

CHAPTER 1

ANSWERS

Multiple Choice Questions

1. (d) 2. (c)
3. (c) **Hint**— The substance which oxidises the other substances in a chemical reaction is known as an oxidising agent. Likewise, the substance which reduces the other substance in a chemical reaction is known as reducing agent.
4. (a) 5. (c) 6. (a) 7. (b)
8. (a) 9. (b) 10. (d) 11. (b)
12. (d)
13. (b) **Hint**— Lead sulphate being insoluble will not dissociate into Pb^{2+} ions.
14. (d) 15. (a) 16. (d) 17. (d)
18. (d)

Short Answer Questions

19. (a) $\text{N}_2(\text{g}) + 3\text{H}_2(\text{g}) \xrightarrow[773 \text{ K}]{\text{Catalyst}} 2\text{NH}_3(\text{g})$
Combination reaction
- (b) $\text{NaOH}(\text{aq}) + \text{CH}_3\text{COOH}(\text{aq}) \longrightarrow \text{CH}_3\text{COONa}(\text{aq}) + \text{H}_2\text{O}(\text{l})$
Double displacement reaction/Neutralisation reaction
- (c) $\text{C}_2\text{H}_5\text{OH}(\text{l}) + \text{CH}_3\text{COOH}(\text{l}) \xrightarrow{\text{H}^+} \text{CH}_3\text{COOC}_2\text{H}_5(\text{l}) + \text{H}_2\text{O}(\text{l})$
Double displacement reaction/Esterification reaction
- (d) $\text{C}_2\text{H}_4(\text{g}) + 3\text{O}_2(\text{g}) \longrightarrow 2\text{CO}_2(\text{g}) + 2\text{H}_2\text{O}(\text{g}) + \text{Heat} + \text{Light}$
Redox reaction/Combustion reaction

20. (a) $\text{Fe}_2\text{O}_3(\text{s}) + 2\text{Al}(\text{s}) \longrightarrow \text{Al}_2\text{O}_3(\text{s}) + 2\text{Fe}(\text{l}) + \text{Heat}$
Displacement reaction/Redox reaction

(b) $3\text{Mg}(\text{s}) + \text{N}_2(\text{g}) \longrightarrow \text{Mg}_3\text{N}_2(\text{s})$
Combination reaction

(c) $2\text{KI}(\text{aq}) + \text{Cl}_2(\text{g}) \longrightarrow 2\text{KCl}(\text{aq}) + \text{I}_2(\text{s})$
Displacement reaction

(d) $\text{C}_2\text{H}_5\text{OH}(\text{l}) + 3\text{O}_2(\text{g}) \longrightarrow 2\text{CO}_2(\text{g}) + 3\text{H}_2\text{O}(\text{l}) + \text{Heat}$
Redox reaction/Combustion reaction

21. (a) $x \longrightarrow (\text{s})$
 $y \longrightarrow (\text{aq})$
(b) $x \longrightarrow 2 \text{Ag}$
(c) $x \longrightarrow (\text{aq})$
 $y \longrightarrow (\text{g})$
(d) $x \longrightarrow \text{Heat}$

22. (b) and (c) are exothermic as heat is released in these changes.
(a) and (d) are endothermic as heat is absorbed in these changes

23. (a) Ammonia (NH_3)
(b) Water (H_2O) as F_2 is getting reduced to HF
(c) Carbon monoxide (CO)
(d) Hydrogen

Hint—Reducing agents are those substances which have the ability of adding hydrogen or removing oxygen from the other substances.

24. (a) Pb_3O_4
(b) O_2
(c) CuSO_4
(d) V_2O_5
(e) H_2O
(f) CuO

25. (a) $\text{Na}_2\text{CO}_3 + \text{HCl} \longrightarrow \text{NaCl} + \text{NaHCO}_3$
(b) $\text{NaHCO}_3 + \text{HCl} \longrightarrow \text{NaCl} + \text{H}_2\text{O} + \text{CO}_2$
(c) $2\text{CuSO}_4 + 4\text{KI} \longrightarrow \text{Cu}_2\text{I}_2 + 2\text{K}_2\text{SO}_4 + \text{I}_2$

26. $\text{KCl}(\text{aq}) + \text{AgNO}_3(\text{aq}) \longrightarrow \text{AgCl}(\text{s}) + \text{KNO}_3(\text{aq})$

It is a double displacement and precipitation reaction.

27. $2\text{FeSO}_4(\text{s}) \xrightarrow{\text{Heat}} \text{Fe}_2\text{O}_3(\text{s}) + \text{SO}_2(\text{g}) + \text{SO}_3(\text{g})$

It is a thermal decomposition reaction

- 28.** Fire flies have a protein which in the presence of an enzyme undergoes aerial oxidation. This is a chemical reaction which involves emission of visible light. Therefore, fire flies glow at night.
- 29.** Grapes when attached to the plants are living and therefore their own immune system prevents fermentation. The microbes can grow in the plucked grapes and under anaerobic conditions these can be fermented. This is a chemical change.
- 30.** (a), (c) and (e) — are physical changes.
(b) and (d) are chemical changes
- 31. Hint—** (a) Silver metal does not react with dilute HCl
(b) The temperature of the reaction mixture rises when aluminium is added because it is an exothermic reaction.
(c) Reaction of sodium metal is found to be highly explosive because it is an exothermic reaction
(d) When lead is treated with hydrochloric acid, bubbles of hydrogen gas are evolved
$$\text{Pb} + 2\text{HCl} \rightarrow \text{PbCl}_2 + \text{H}_2$$
- 32.** Calcium oxide
$$\text{CaO(s)} + \text{H}_2\text{O(l)} \longrightarrow \text{Ca(OH)}_2\text{(aq)}$$
- 33.** (a) $\text{Pb(CH}_3\text{COO)}_2 + 2\text{HCl} \longrightarrow \text{PbCl}_2 + \text{CH}_3\text{COOH}$; Double displacement reaction
(b) $2\text{Na} + 2\text{C}_2\text{H}_5\text{OH} \longrightarrow 2\text{C}_2\text{H}_5\text{ONa} + \text{H}_2$; Displacement reaction
(c) $\text{Fe}_2\text{O}_3 + 3\text{CO} \longrightarrow 2\text{Fe} + 3\text{CO}_2$; Redox reaction
(d) $2\text{H}_2\text{S} + \text{O}_2 \longrightarrow 2\text{S} + 2\text{H}_2\text{O}$; Redox reaction
- 34.** Silver chloride on exposure to sunlight may decompose as per the following reaction.
$$2\text{AgCl} \longrightarrow 2\text{Ag} + \text{Cl}_2$$

Therefore, it is stored in dark coloured bottles.
- 35.** (a) Balanced; Combination reaction
(b) $2\text{HgO (s)} \xrightarrow{\text{Heat}} 2\text{Hg (l)} + \text{O}_2 \text{ (g)}$; Decomposition reaction
(c) $2\text{Na (s)} + \text{S (s)} \xrightarrow{\text{Fuse}} \text{Na}_2\text{S (s)}$; Combination reaction
(d) $\text{TiCl}_4 \text{ (l)} + 2\text{Mg (s)} \longrightarrow \text{Ti (s)} + 2\text{MgCl}_2 \text{ (s)}$; Displacement reaction
(e) Balanced; Combination reaction
(f) $2\text{H}_2\text{O}_2 \text{ (l)} \xrightarrow{\text{U V}} 2\text{H}_2\text{O (l)} + \text{O}_2 \text{ (g)}$; Decomposition reaction

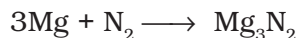
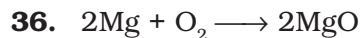

(a) X is MgO; Y is Mg_3N_2



37. Zinc is above hydrogen whereas copper is below hydrogen in the activity series of metals. That is why zinc displaces hydrogen from dilute hydrochloric acid, while copper does not.

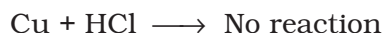
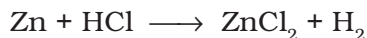

38. (a) Metals such as silver when attacked by substances around it such as moisture, acids, gases etc, are said to corrode and this phenomenon is called corrosion.
- (b) The black substance is formed because silver (Ag) reacts with H_2S present in air. It forms thin black coating of silver sulphide (Ag_2S).

Long Answer Questions

39. (a) Balanced chemical equation



(b) The brown gas X evolved is nitrogen dioxide (NO_2)

(c) This is a decomposition reaction

(d) Nitrogen dioxide dissolves in water to form acidic solution because it is an oxide of non-metal. Therefore, pH of this solution is less than 7

40. The characteristic test for

(a) Carbon dioxide (CO_2) gas turns lime water milky when passed through it due to the formation of insoluble calcium carbonate.



Lime water	Carbon	Calcium
	dioxide	carbonate

(b) Sulphur dioxide (SO_2) gas when passed through acidic potassium permanganate solution (purple in colour) turns it colourless because SO_2 is a strong reducing agent



Potassium permanganate (Purple)	Sulphur dioxide	Potassium sulphate (Colourless)	Manganese sulphate (Colourless)
------------------------------------	-----------------	------------------------------------	------------------------------------

or

Sulphur dioxide gas when passed through acidic dichromate solution (orange in colour) turns it to green because sulphur dioxide is a strong reducing agent.

- (c) The evolution of oxygen (O₂) gas during a reaction can be confirmed by bringing a burning candle near the mouth of the test tube containing the reaction mixture. The intensity of the flame increases because oxygen supports burning.
- (d) Hydrogen (H₂) gas burns with a pop sound when a burning candle is brought near it.
- 41.** (a) Zinc being more reactive than copper displaces copper from its solution and a solution of zinc sulphate is obtained
- $$\text{Zn(s)} + \text{CuSO}_4(\text{aq}) \rightarrow \text{ZnSO}_4(\text{aq}) + \text{Cu(s)}$$
- Blue Colourless
- This is an example of displacement reaction
- (b) Aluminium being more reactive displaces hydrogen from dilute hydrochloric acid solution and hydrogen gas is evolved.
- $$2\text{Al(s)} + 6\text{HCl(aq)} \rightarrow 2\text{AlCl}_3(\text{aq}) + 3\text{H}_2(\text{g})$$
- Aluminium
chloride
- (c) Silver metal being less reactive than copper cannot displace copper from its salt solution. Therefore, no reaction occurs
- $$\text{Ag(s)} + \text{CuSO}_4(\text{aq}) \rightarrow \text{No reaction}$$

42. The reaction of Zn granules with

(a) Dilute H₂SO₄

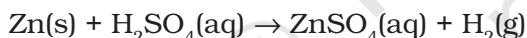

(b) Dilute HCl



(c) Dilute HNO₃

Reaction with dilute HNO₃ is different as compared to other acids because nitric acid is an oxidising agent and it oxidises H₂ gas evolved to H₂O.

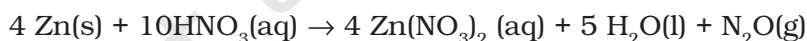

(d) NaCl solution

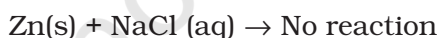

(e) NaOH solution

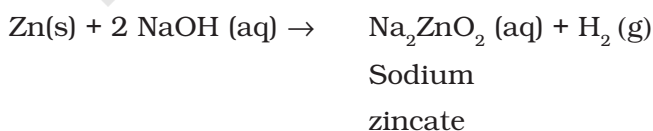

43. (a) Balanced chemical equation

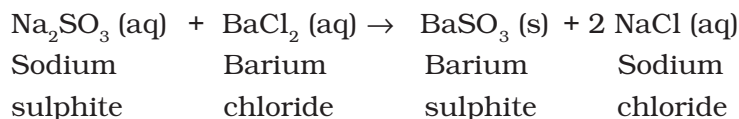

(b) This reaction is also known as double displacement reaction

(c) BaSO_3 is a salt of a weak acid (H_2SO_3), therefore dilute acid such as HCl decomposes barium sulphite to produce sulphur dioxide gas which has the smell of burning sulphur.



White ppt.

BaCl_2 is soluble in water, hence white precipitate disappears

44. (A) When solutions are kept in copper container

(a) Dilute HCl

Copper does not react with dilute HCl. Therefore, it can be kept.

(b) Dilute HNO_3

Nitric acid acts as a strong oxidising agent and reacts with copper vessel, therefore cannot be kept.

(c) ZnCl_2

Zinc is more reactive than copper (Cu) therefore, no displacement reaction occurs and hence can be kept.

(d) H_2O

Copper does not react with water. Therefore, can be kept.

(B) When solutions are kept in aluminium containers

(a) Dilute HCl

Aluminium reacts with dilute HCl to form its salt and hydrogen is evolved. Therefore, cannot be kept.

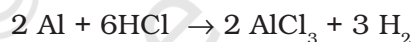

(b) Dilute HNO_3

Aluminium gets oxidised by dilute HNO_3 to form a layer of Al_2O_3 and can be kept.

(c) ZnCl_2

Aluminium being more reactive than zinc can displace zinc ion from the solution. Therefore, the solution cannot be kept.

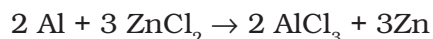

(d) H_2O

Aluminium does not react with cold or hot water. Therefore, water can be kept.

Aluminium is attacked by steam to form aluminium oxide and hydrogen

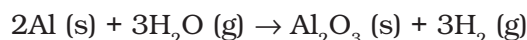

CHAPTER 2

ANSWERS

Multiple Choice Questions

1. (d) 2. (d) 3. (c) 4. (b)
5. (d) 6. (a) 7. (d) 8. (a)
9. (b) 10. (b) 11. (c) 12. (b)
13. (c) 14. (d) 15. (a) 16. (b)
17. (c) 18. (d) 19. (a) 20. (c)
21. (d) 22. (b) 23. (d) 24. (b)
25. (c) 26. (c)
27. (c) **Hint**— Though HCl gas is a covalent compound, in the aqueous solution it ionizes to form H^+ (aq) and Cl^- (aq) ions.
28. (c) 29. (a) 30. (d)

Short Answer Questions

31. (a)— (iv) (b)— (iii) (c)— (ii) (d)— (i)
32. (a)— (ii) (b)— (iii) (c)— (iv) (d)— (i)

33.	Substance	Action on Litmus paper
	Dry HCl gas	No change
	Moistened NH_3 gas	Turns red to blue
	Lemon juice	Turns blue to red
	Carbonated soft drink	Turns blue to red
	Curd	Turns blue to red
	Soap solution	Turns red to blue

34. The acid present in ant sting is methanoic acid (formic acid). The chemical formula is HCOOH . To get relief one should apply any available basic salt e.g., baking soda (NaHCO_3) on it.

35. Egg shells contain calcium carbonate. When nitric acid is added to it, carbon dioxide gas is evolved. The reaction can be given as



36. **Hint**— Using chemical indicator like phenolphthalein or natural indicators like turmeric, china rose etc.

37. The chemical formula of baking powder is sodium hydrogencarbonate (NaHCO_3). Whereas, that of washing soda is sodium carbonate ($\text{Na}_2\text{CO}_3 \cdot 10\text{H}_2\text{O}$)

Sodium hydrogencarbonate on heating gives CO_2 gas which will turn lime water milky whereas no such gas is obtained from sodium carbonate.

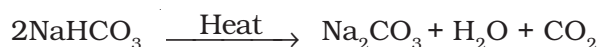

38. Baking powder (NaHCO_3), salt A is commonly used in bakery products. On heating it forms sodium carbonate (Na_2CO_3), B and CO_2 gas, C is evolved. When CO_2 gas is passed through lime water it forms calcium carbonate (CaCO_3), which is slightly soluble in water making it milky.

A — NaHCO_3

B — Na_2CO_3

C — CO_2 gas

39. In the manufacture of sodium hydroxide, hydrogen gas and chlorine gas (X) are formed as by-products. When chlorine gas (X) reacts with lime water, it forms calcium oxychloride (bleaching powder) Y. The reactions are



X → Cl_2 (Chlorine gas)

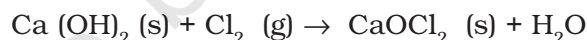

Y — Calcium oxychloride (bleaching powder)

40.	Name of the salt	Formula	Salt obtained from	
			Base	Acid
(i)	Ammonium chloride	NH_4Cl	NH_4OH	HCl
(ii)	Copper sulphate	CuSO_4	$\text{Cu}(\text{OH})_2$	H_2SO_4
(iii)	Sodium chloride	NaCl	NaOH	HCl
(iv)	Magnesium nitrate	$\text{Mg}(\text{NO}_3)_2$	$\text{Mg}(\text{OH})_2$	HNO_3
(v)	Potassium sulphate	K_2SO_4	KOH	H_2SO_4
(vi)	Calcium nitrate	$\text{Ca}(\text{NO}_3)_2$	$\text{Ca}(\text{OH})_2$	HNO_3

41. In aqueous solutions strong acids ionise completely and provide hydronium ions. On the other hand weak acids are partially ionised and an aqueous solution of same molar concentration provides a much smaller concentration of H_3O^+ ions.

Strong acids — Hydrochloric acid, sulphuric acid, nitric acid

Weak acid — Citric acid, acetic acid, formic acid

42. When zinc reacts with dilute solution of strong acid, it forms salt and hydrogen gas is evolved.

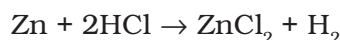

When a burning splinter is brought near the mouth of the test tube, the gas burns with a pop sound.

Long Answer Questions

43. **Hint—** (a) Hydrogen gas will evolve with greater speed

(b) Almost same amount of gas is evolved

(c) Hydrogen gas is not evolved

(d) If sodium hydroxide is taken, hydrogen gas will be evolved

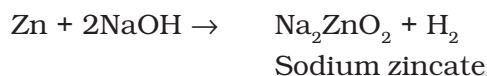

44. (a) Baking soda is sodium hydrogencarbonate. On heating, it is converted into sodium carbonate which is bitter to taste

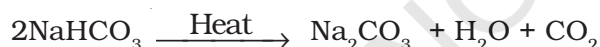

(b) Baking soda can be converted into baking powder by the addition of appropriate amount of tartaric acid to it.

(c) The role of tartaric acid is to neutralise sodium carbonate and cake will not taste bitter.

45. The gas evolved at anode during electrolysis of brine is chlorine (G)

When chlorine gas is passed through dry $\text{Ca}(\text{OH})_2$ (Y) produces bleaching powder (Z) used for disinfecting drinking water.

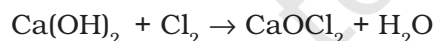

Slaked Bleaching

lime powder

Since Y and Z are calcium salts, therefore X is also a calcium salt and is calcium carbonate.

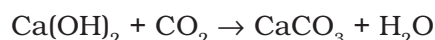
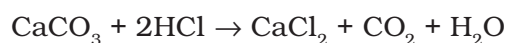

46. Sodium hydroxide (NaOH) is a commonly used base and is hygroscopic, that is, it absorbs moisture from the atmosphere and becomes sticky.

The acidic oxides react with base to give salt and water. The reaction between NaOH and CO₂ can be given as



47. The substance which is used for making different shapes is Plaster of Paris. Its chemical name is calcium sulphate hemihydrate (CaSO₄ · ½H₂O). The two formula unit of CaSO₄ share one molecule of water. As a result, it is soft.

When it is left open for some time, it absorbs moisture from the atmosphere and forms gypsum, which is a hard solid mass.

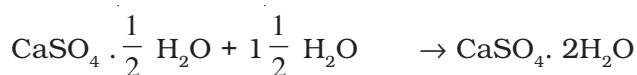

Plaster of Paris

(Soft)

(Sulphate salt)

Gypsum

(Hard mass)

48. X— NaOH (Sodium hydroxide)
A— Na₂ZnO₂ (Sodium zincate)
B— NaCl (Sodium chloride)
C— CH₃COONa (Sodium acetate)



CHAPTER 3

ANSWERS

Multiple Choice Questions

1. (c) 2. (a) 3. (d) 4. (d)
5. (c) **Hint**— $3 \text{ Fe (s)} + 4 \text{ H}_2\text{O (g)} \rightarrow \text{Fe}_3\text{O}_4 \text{ (s)} + 4 \text{ H}_2 \text{ (g)}$
6. (d) 7. (c) 8. (c) 9. (b)
10. (b) 11. (c) 12. (a) 13. (c)
14. (c) 15. (a) 16. (b) 17. (d)
18. (d) 19. (d)
20. (b) **Hint**— Reactivity series $\text{Mg} > \text{Zn} > \text{Cu} > \text{Ag}$
21. (b) 22. (c) 23. (b) 24. (a)
25. (b) 26. (d) 27. (b) 28. (d)
29. (b) 30. (d) 31. (c) 32. (b)
33. (c) 34. (b) 35. (d) 36. (c)

Short Answer Questions

37. The produced gas can be identified by bringing a burning match stick near the reaction vessel, a pop sound is produced
- $$\text{M} + 2\text{NaOH} \rightarrow \text{Na}_2\text{MO}_2 + \text{H}_2$$
- $$\text{M} + 2\text{HCl} \rightarrow \text{MCl}_2 + \text{H}_2$$
- The element is a metal
38. (a) Anode : Impure silver
Cathode : Pure silver
- (b) Electrolyte: Silver salt, such as AgNO_3
- (c) We get pure silver at cathode
39. It is easier to obtain metal from its oxide, as compared from its sulphides and carbonates.

40. It is because HNO_3 is a strong oxidising agent. It oxidises the H_2 produced to H_2O .
41. (a) X — Fe_2O_3 (b) Thermite reaction
 (c) $\text{Fe}_2\text{O}_3(\text{s}) + 2\text{Al}(\text{s}) \rightarrow 2\text{Fe}(\text{l}) + \text{Al}_2\text{O}_3(\text{s}) + \text{Heat}$
42. X — Na, Y — NaOH, Z — H_2
 $2\text{Na} + 2\text{H}_2\text{O} \rightarrow 2\text{NaOH} + \text{H}_2 + \text{Heat energy}$
43. X — Carbon; Y — Diamond and Z — Graphite
44. (a) No, because oxygen is added to aluminium therefore, it is getting oxidised
 (b) No, since manganese has lost oxygen therefore, it is getting reduced.
45. Solder is an alloy of lead and tin. Low melting point of solder makes it suitable for welding electrical wires.
46. A — Al; B — Al_2O_3
 $\text{Al}_2\text{O}_3 + 6\text{HCl} \rightarrow 2\text{AlCl}_3 + 3\text{H}_2\text{O}$
 $\text{Al}_2\text{O}_3 + 2\text{NaOH} \rightarrow 2\text{NaAlO}_2 + \text{H}_2\text{O}$
47. Metals low in activity series can be obtained by reducing their sulphides or oxides by heating. Mercury is the only metal that exists as liquid at room temperature. It can be obtained by heating cinnabar (HgS), the sulphide ore of mercury.
 The reactions are as follows:
 $2\text{HgS} + 3\text{O}_2 \xrightarrow{\text{Heat}} 2\text{HgO} + 2\text{SO}_2$
 $2\text{HgO} \xrightarrow{\text{Heat}} 2\text{Hg} + \text{O}_2$
48. (a) Mg_3N_2 (b) Li_2O (c) AlCl_3 (d) K_2O
49. (a) It undergoes calcination. The chemical reaction can be given as
 $\text{ZnCO}_3 \xrightarrow{\text{Heat}} \text{ZnO} + \text{CO}_2$
 (b) It undergoes auto reduction forming copper and sulphur dioxide
 $2\text{Cu}_2\text{O} + \text{Cu}_2\text{S} \xrightarrow{\text{Heat}} 6\text{Cu} + \text{SO}_2$
50. (a) A is carbon, B is carbon monoxide and C is carbon dioxide
 (b) A belongs to Group – 14 of the Periodic Table
51. (a) Good conductor : Ag and Cu
 (b) Poor conductor : Pb and Hg

52. Metal – Mercury (Hg); Non-metal – Bromine (Br)

Two metals with melting points less than 310K are Cesium (Cs) and Gallium (Ga)

53. A – Ca; B – Ca(OH)₂; C – CaO



54. A – Na; B – NaOH; C – NaAlO₂

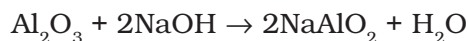
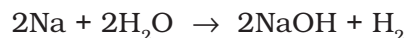

55. (a) $2\text{ZnS}(\text{s}) + 3\text{O}_2 \xrightarrow{\text{Heat}} 2\text{ZnO}(\text{s}) + 2\text{SO}_2(\text{g})$

(b) $\text{ZnCO}_3(\text{s}) \xrightarrow{\text{Heat}} \text{ZnO}(\text{s}) + \text{CO}_2(\text{g})$

56. M = Cu; Black product – CuO

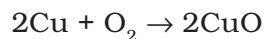

57. Since an oxide of element is acidic in nature, therefore, A will be a non-metal.

58. Fe is more reactive as compared to Cu. Therefore, Fe displaces Cu from CuSO₄ and forms FeSO₄.

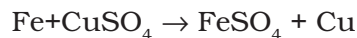

Long Answer Questions

59. (a) A – N₂; B – NH₃; C – NO; D – HNO₃

(b) Element **A** belongs to Group –15 of the Periodic Table

60. Sulphide ore of low reactivity metal

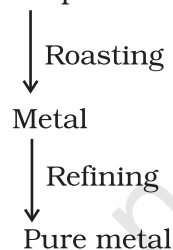

Sulphide ore of medium reactivity metal

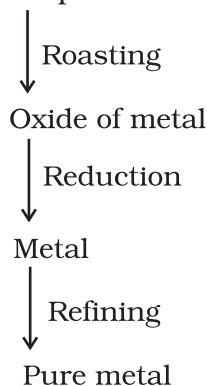

- 61. Hint—** (a) Due to the formation of a layer of oxide i.e., Al_2O_3
 (b) Na or Mg are more reactive metals as compared to carbon
 (c) In solid NaCl, the movement of ions is not possible due to its rigid structure but in aqueous solution or molten state, the ions can move freely.
 (d) To protect from corrosion
 (e) They are highly reactive

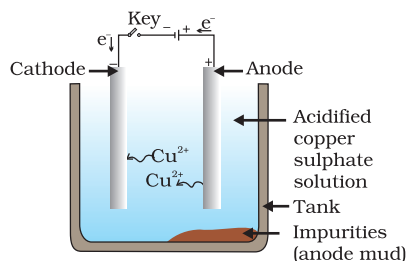

- 62. (i)** (a) Roasting of sulphide ore



This reaction is known as auto-reduction

- (c) Reaction for electrolytic refining

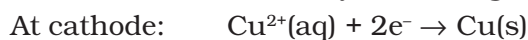

- (ii) Diagram for electroytic refining of copper

- 63.** X is alkali metal, Na or K

Y is alkaline earth metal, Mg or Ca

Z is Fe

Increasing reactivity series: $\text{Na} > \text{Mg} > \text{Fe}$

- 64.** A = Na; B = Cl_2 ; C = NaCl; D = NaOH

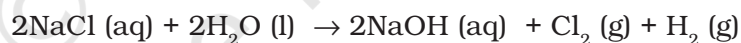
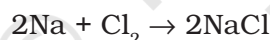

- 65.** Since ore A gives CO_2 and ore B gives SO_2 . Therefore, ores are MCO_3 and MS.

A can be obtained

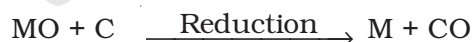

B can be obtained



CHAPTER 4

ANSWERS

Multiple Choice Questions

- | | | | |
|---------|---------|---------|---------|
| 1. (b) | 2. (d) | 3. (a) | 4. (c) |
| 5. (c) | 6. (b) | 7. (a) | 8. (b) |
| 9. (a) | 10. (d) | 11. (a) | 12. (d) |
| 13. (b) | 14. (a) | 15. (c) | 16. (c) |
| 17. (c) | 18. (d) | 19. (c) | 20. (a) |
| 21. (b) | 22. (c) | 23. (d) | 24. (c) |
| 25. (d) | 26. (a) | 27. (d) | 28. (d) |
| 29. (a) | | | |

Short Answer Questions

30. $\text{H} : \text{C} \begin{array}{c} \cdot\cdot \\ \cdot\cdot \end{array} \text{C} : \text{H}$ Electron dot structure of ethyne (C_2H_2)
 $\text{H} - \text{C} \equiv \text{C} - \text{H}$ Structural formula of ethyne
31. (a) Pentanoic acid
(b) Butyne
(c) Heptanal
(d) Pentanol
32. (a) $-\text{OH}$ Hydroxyl/Alcohol
(b) $\begin{array}{c} -\text{C}-\text{OH} \\ || \\ \text{O} \end{array}$ Carboxylic acid
(c) $\begin{array}{c} \text{O} \\ || \\ -\text{C}- \end{array}$ Ketone
(d) $-\overset{|}{\text{C}}=\overset{|}{\text{C}}-$ Alkene
33. (a) Carboxylic acid is ethanoic acid
(b) Alcohol is ethanol
(c) X is ethyl ethanoate

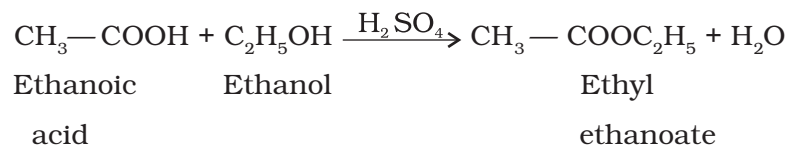

34. Detergents work as cleansing agent both in hard and soft water. The charged ends of detergents do not form insoluble precipitates with calcium and magnesium ions in hard water.

- 35.** (a) Ketone
 (b) Carboxylic acid
 (c) Aldehyde
 (d) Alcohol

36. Ethanol on heating with excess concentrated sulphuric acid at 443 K results in the dehydration of ethanol to give ethene.

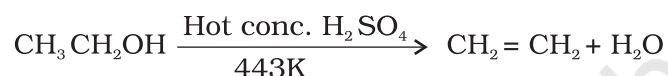

37. Methanol is oxidised to methanal in the liver. Methanal reacts rapidly with the components of cells. It causes the protoplasm to coagulate. It also affects the optic nerve, causing blindness.

38. Gas evolved is hydrogen.

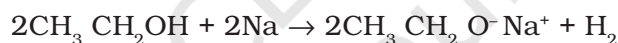

39. Sulphuric acid acts as a dehydrating agent.

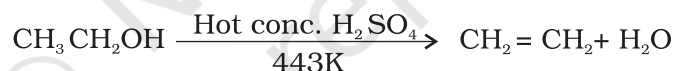

- 40.** (a) Carbon tetrachloride (CCl₄)
 (b) Carbon dioxide (CO₂)

- 41.** (a) K, L, M
 2, 8, 7



42. Carbon exhibits catenation much more than silicon or any other element due to its smaller size which makes the C–C bonds strong while the Si–Si bonds are comparatively weaker due to its large size.

43. Hint— The two can be distinguished by subjecting them to the flame. Saturated hydrocarbons generally give a clear flame while unsaturated hydrocarbons give a yellow flame with lots of black smoke.

44. (a) —(iv) (b) — (i)
 (c) — (ii) (d) — (iii)

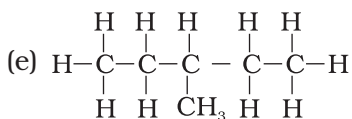
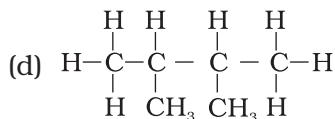
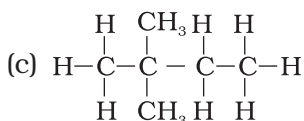
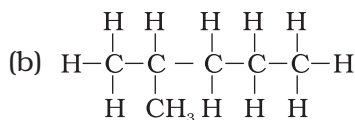
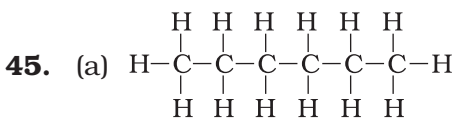

46. **Hint—** (a) Ni acts as a catalyst
 (b) Concentrated H_2SO_4 acts as a catalyst
 (c) Alkaline KMnO_4 acts as an oxidising agent

Long Answer Questions

47. $\text{CH}_3\text{COOH} + \text{NaHCO}_3 \rightarrow \text{CH}_3\text{COO Na} + \text{H}_2\text{O} + \text{CO}_2$
 X is sodium ethanoate

Gas evolved is carbon dioxide

Hint— Activity

Lime water will turn milky, a characteristic property of CO_2 gas

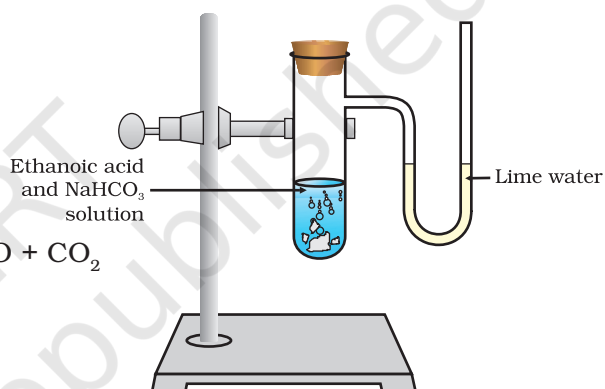

48. (a) Compounds of carbon and hydrogen are called hydrocarbons. Example, methane, ethane etc.
 (b) Saturated hydrocarbons contain carbon- carbon single bonds. Unsaturated hydrocarbons contain atleast one carbon - carbon double or triple bond.

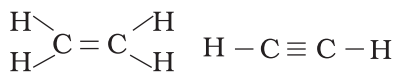
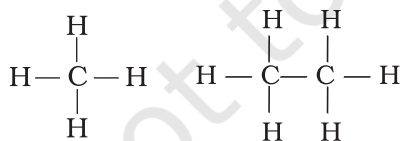

Methane

Ethane

Ethene

Ethyne

Saturated hydrocarbons

Unsaturated hydrocarbons

- (c) Functional group – An atom/group of atoms joined in a specific manner which is responsible for the characteristic chemical properties of the organic compounds. Examples are hydroxyl group ($-\text{OH}$), aldehyde group ($-\text{CHO}$), carboxylic group ($-\text{COOH}$) etc.

49. Hint— Hydrogenation reaction

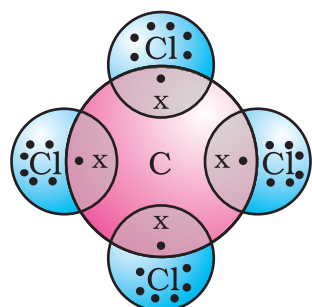
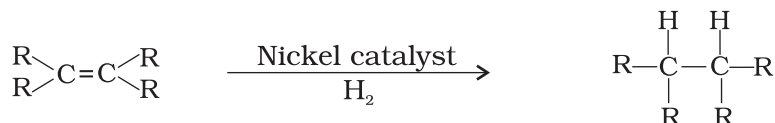

50. a) CCl_4

(b) Saponification is the process of converting esters into salts of carboxylic acids and ethanol by treating them with a base.

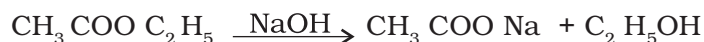

51. Activity

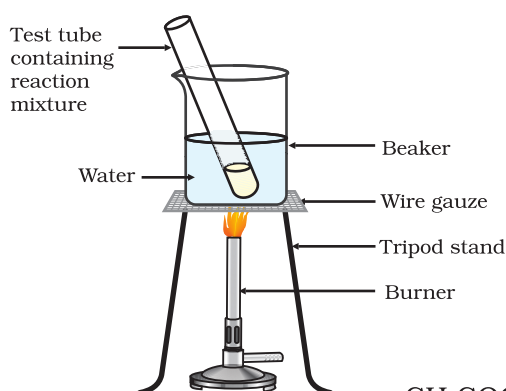

- Take 1 mL ethanol (absolute alcohol) and 1 mL glacial acetic acid along with a few drops of concentrated sulphuric acid in a test tube.
- Warm in a water-bath at about 60°C for at least 15 minutes as shown in the Figure (It should not be heated directly on flame as the vapours of ethanol catch fire)
- Pour into a beaker containing 20-50 mL of water and smell the resulting mixture.



52. C — Ethanoic acid

R — Sodium salt of ethanoic acid (sodium acetate) and gas evolved is hydrogen

A — Methanol

S — Ester (Methyl acetate)

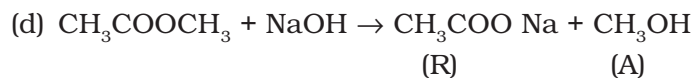
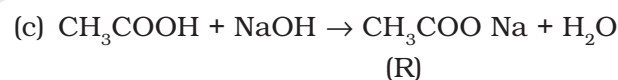
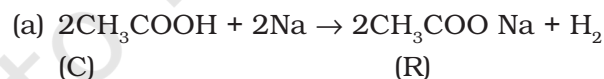

53. (a) It will turn milky
- (b) $2\text{CH}_3\text{COOH} + \text{Na}_2\text{CO}_3 \rightarrow 2\text{CH}_3\text{COONa} + \text{H}_2\text{O} + \text{CO}_2$ (Test tube A)
 $\text{Ca}(\text{OH})_2 + \text{CO}_2 \rightarrow \text{CaCO}_3 + \text{H}_2\text{O}$ (Test tube B)
 With excess CO_2 , milky disappears.
 $\text{CaCO}_3 + \text{H}_2\text{O} + \text{CO}_2 \rightarrow \text{Ca}(\text{HCO}_3)_2$
- (c) As $\text{C}_2\text{H}_5\text{OH}$ and Na_2CO_3 do not react, a similar change is not expected
 $\text{C}_2\text{H}_5\text{OH} + \text{Na}_2\text{CO}_3 \rightarrow \text{No change}$
- (d) The lime water is prepared by dissolving calcium oxide in water and decanting the supernatant liquid.

54. **Hint—** (a) By the dehydration of ethanol in the presence of concentrated H_2SO_4 .



- (b) By the oxidation of propanol using oxidising agent such as alkaline KMnO_4 .

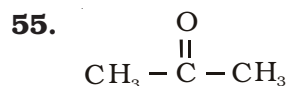

Propanone

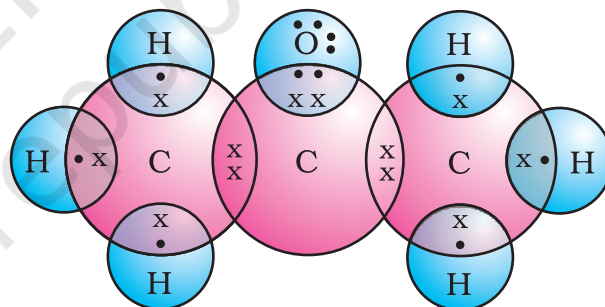

Electron dot structure of propanone



Propanal

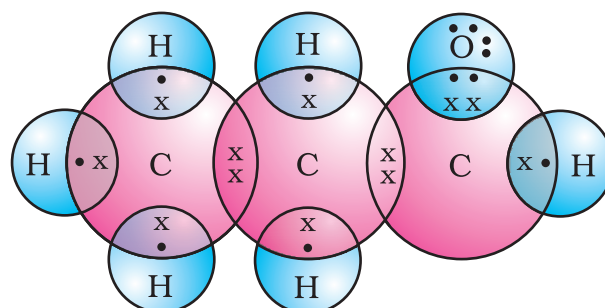

Electron dot structure of propanal

- 56. Hint—** (a) Unsaturated hydrocarbons add hydrogen in the presence of nickel catalyst to give saturated hydrocarbons.

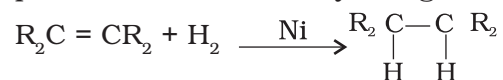

- (b) Ethanol is oxidised to ethanoic acid in the presence of alkaline $KMnO_4$ on heating.



- (c) In the presence of sunlight, chlorine is added to hydrocarbons.

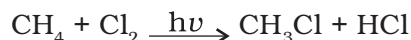

- (d) $CH_3COOC_2H_5 + NaOH \rightarrow CH_3COONa + C_2H_5OH$
Ester

Used in the preparation of soap

- (e) Most carbon compounds release a large amount of heat and light on burning



- 57.** Since compound C gives 2 moles of CO_2 and 3 moles of H_2O , it shows that it has the molecular formula C_2H_6 (Ethane). C is obtained by the addition of one mole of hydrogen to compound B so the molecular formula of B should be C_2H_4 (Ethene). Compound B is obtained by heating compound A with concentrated H_2SO_4 which shows it to be an alcohol. So compound A could be C_2H_5OH (Ethanol)

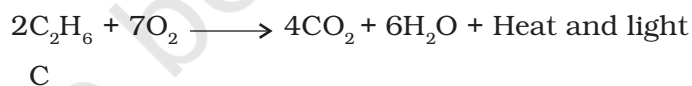
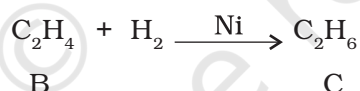
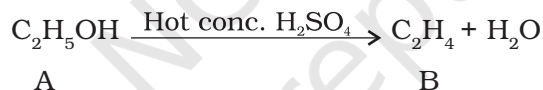

CHAPTER 5

ANSWERS

Multiple Choice Questions

1. (b) 2. (c) 3. (a) 4. (b)
5. (c) 6. (b) 7. (c) 8. (c)
9. (b) 10. (b) 11. (d) 12. (d)
13. (c) 14. (c) 15. (b) 16. (d)
17. (b) 18. (b) 19. (c) 20. (c)
21. (a) 22. (b) 23. (b) 24. (c)
25. (b) 26. (a)

Short Answer Questions

27. The arrangement of these elements is known as Döbereiner triad.
Example, Lithium, Sodium and Potassium
28. (a) (i) F and Cl (ii) Na and K.
(b) Newland's law of octaves
29. (a) No, because all these elements do not have similar properties although the atomic mass of silicon is average of atomic masses of sodium (Na) and chlorine (Cl).
(b) Yes, because they have similar properties and the mass of magnesium (Mg) is roughly the average of the atomic mass of Be and Ca.
30. **Hint**— Elements with similar properties can be grouped together.
31. **Hint**— Hydrogen resembles alkali metals as well as halogens
32. GeCl_4 , GaCl_3

33.

Element	Group No.	Valency
A	Group-13	3
B	Group-14	4
C	Group-2	2

34. XCl_4 ; Covalent bonding

35. **Hint**— Radii of Y is less than X because Y is cation of X

36. (a) $\text{F} < \text{N} < \text{Be} < \text{Li}$

(b) $\text{Cl} < \text{Br} < \text{I} < \text{At}$

37. (a), (b) and (d)

(a) Magnesium (b) Sodium (d) Lithium

38. **Hint**— A B 

Ionic bond.

A = K (Potassium) B = Cl (Chlorine)

39. $\text{Ge} < \text{Ga} < \text{Mg} < \text{Ca} < \text{K}$

40. (a) Na or K (b) Ca (c) Hg

$\text{Hg} < \text{Ca} < \text{Na} < \text{K}$

41. (a) Sodium (Na) Group 1 and Period 3 or Potassium (K) Group 1 and Period 4

(b) Phosphorus (P) Group 15 and Period 3

(c) Carbon (C) Group 14 and Period 2

(d) Helium (He) Group 18 and Period 1

(e) Aluminium (Al) Group 13 and Period 3

Long Answer Questions

42. (a) Magnesium (Mg)

(b) K, L, M

2, 8, 2

(c) $2\text{Mg}(\text{s}) + \text{O}_2(\text{g}) \rightarrow 2\text{MgO}(\text{s})$

(d) $\text{MgO}(\text{s}) + \text{H}_2\text{O}(\text{l}) \rightarrow \text{Mg}(\text{OH})_2(\text{aq})$

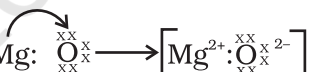
(e) 

43. (a) X belongs to Group 17 and 3rd period

Y belongs to Group 2 and 4th period

(b) X — Non-metal and Y — Metal

(c) Basic oxide; Ionic bonding

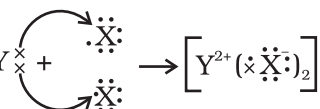
(d) 

44. (a) Elements— Neon (Ne), Calcium (Ca), Nitrogen (N), Silicon (Si)
 (b) Group— 18, 2, 15, 14
 (c) Period— 2, 4, 2, 3
 (d) Electron configuration— (2, 8); (2, 8, 8, 2); (2, 5); (2, 8, 4)
 (e) Valency— 0, 2, 3, 4

45.

	¹ M	⁷ A	G	N	E	² S	I	U	M		
		S				O					
		³ T	⁸ I	N		D	⁹ B		⁵ L		
		A	R			⁴ I	O	D	I	⁶ N	E
		T	O			U	R		T	E	
		I	N			M	O		H	O	
		N					N		I	N	
		E							U		
									M		

46. (a) H, He, Li, Be, B, C, N, O, F, Ne, Na, Mg, Al, Si, P, S, Cl, Ar, K, Ca
 (b) Group 1 — H, Li, Na, K
 Group 2 — Be, Mg, Ca
 Group 13 — B, Al
 Group 14 — C, Si
 Group 15 — N, P
 Group 16 — O, S
 Group 17 — F, Cl
 Group 18 — He, Ne, Ar
47. (a) Germanium (Ge) and Gallium (Ga)
 (b) Group 14; Period 4 and Group 13; Period 4
 (c) Ge — Metalloid; Ga — Metal
 (d) Ga — 3 Ge — 4
48. (a) Lithium
 (b) Fluorine
 (c) Fluorine
 (d) Boron
 (e) Carbon

49. (a) Element X is sulphur (atomic no. 16)
 (b) K, L, M
 2, 8, 6
 (c) $2\text{FeSO}_4(\text{s}) \xrightarrow{\text{Heat}} \text{Fe}_2\text{O}_3(\text{s}) + \text{SO}_2(\text{g}) + \text{SO}_3(\text{g})$
 (d) Acidic
 (e) 3rd period, group 16

50. (a) Nitrogen (atomic no. 7)
 2,5; it has 5 valence electrons

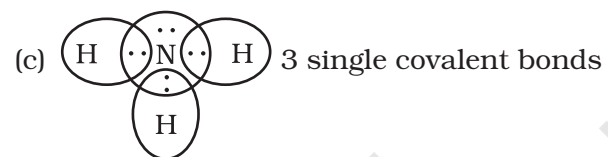

51. Noble gases

According to Mendeleev's classification, the properties of elements are the periodic function of their atomic masses and there is a periodic recurrence of elements with similar physical and chemical properties. Noble gas being inert, could be placed in a separate group without disturbing the original order.

52. (Hint— 63 elements were known.)

- Compounds of these elements with oxygen and hydrogen were studied (formation of oxides and hydrides)
- Elements with similar properties were arranged in a group
- Mendeléev observed that elements were automatically arranged in the order of increasing atomic masses.



CHAPTER 6

ANSWERS

Multiple Choice Questions

- | | | | |
|---------|---------|---------|---------|
| 1. (c) | 2. (b) | 3. (a) | 4. (d) |
| 5. (b) | 6. (b) | 7. (b) | 8. (d) |
| 9. (d) | 10. (d) | 11. (b) | 12. (d) |
| 13. (d) | 14. (d) | 15. (d) | 16. (b) |
| 17. (c) | 18. (a) | 19. (b) | 20. (d) |
| 21. (d) | 22. (d) | 23. (a) | 24. (a) |
| 25. (c) | 26. (c) | 27. (c) | 28. (c) |
| 29. (c) | 30. (b) | 31. (c) | 32. (c) |
| 33. (d) | 34. (c) | 35. (a) | |

Short Answer Questions

36. (a) Photosynthesis
(b) Autotrophs
(c) Chloroplast
(d) Guard Cells
(e) Heterotrophs
(f) Pepsin
37. During day time, as the rate of photosynthesis is more than the rate of respiration, the net result is evolution of oxygen. At night there is no photosynthesis, so they give out carbon dioxide due to respiration.
38. The swelling of guard cells due to absorption of water causes opening of stomatal pores while shrinking of guard cells closes the pores. Opening and closing of stomata occurs due to turgor changes in guard cells. When guard cells are turgid, stomatal pore is open while in flaccid conditions, the stomatal aperture closes.
39. Plant kept in continuous light will live longer, because it will be able to produce oxygen required for its respiration by the process of photosynthesis.

40. Release of CO_2 and intake of O_2 gives evidence that either photosynthesis is not taking place or its rate is too low. Normally during day time, the rate of photosynthesis is much more than the rate of respiration. So, CO_2 produced during respiration is used up for photosynthesis hence CO_2 is not released.

41. Fishes respire with the help of gills. Gills are richly supplied with blood capillaries and can readily absorb oxygen dissolved in water. Since fishes cannot absorb gaseous oxygen they die soon after they are taken out of water.

42.

Autotroph	Heterotroph
1. Organisms that prepare their own food.	1. Organisms that are dependent on other organisms for food.
2. They have chlorophyll.	2. They lack chlorophyll.

43. Food is required for the following purposes

- It provides energy for the various metabolic processes in the body.
- It is essential for the growth of new cells and repair or replacement of worn out cells.
- It is needed to develop resistance against various diseases.

44. Green plants are the sources of energy for all organisms. If all green plants disappear from the earth, all the herbivores will die due to starvation and so will the carnivores.

45. This plant will not remain healthy for a long time because

- it will not get oxygen for respiration.
- it will not get carbon dioxide for photosynthesis.
- Upward movement of water and minerals would be hampered due to lack of transpiration.

46.

Aerobic respiration	Anaerobic respiration
1. Oxygen is utilised for the breakdown of respiratory substrate.	1. Oxygen is not required.
2. It takes place in cytoplasm (glycolysis) and inside mitochondria (Krebs cycle)	2. It takes place in cytoplasm only.
3. End products are carbon dioxide and water	3. End products are lactic acid or ethanol and carbon dioxide.
4. More energy is released.	4. Less energy is released.

47. (a) (ii) (b) (i) (c) (iv) (d) (iii)

48.

Artery	Vein
<ol style="list-style-type: none"> 1. Have thick elastic, muscular walls. 2. Lumen is narrow. 3. Carry blood from heart to all body parts. 4. Carry oxygenated blood (except pulmonary artery). 	<ol style="list-style-type: none"> 1. Have thin, non-elastic, walls. 2. Lumen is wide. 3. Carry blood from all body parts to heart. 4. Carry deoxygenated blood (except pulmonary vein).

49. (a) Leaves provide large surface area for maximum light absorption.
- (b) Leaves are arranged at right angles to the light source in a way that causes overlapping.
- (c) The extensive network of veins enables quick transport of substances to and from the mesophyll cells.
- (d) Presence of numerous stomata for gaseous exchange.
- (e) The chloroplasts are more in number on the upper surface of leaves.
50. Digestion of cellulose takes a longer time. Hence, herbivores eating grass need a longer small intestine to allow complete digestion of cellulose. Carnivorous animals cannot digest cellulose, hence they have a shorter intestine.
51. Gastric glands in stomach release hydrochloric acid, enzyme pepsin and mucus. Mucus protects the inner lining of stomach from the action of hydrochloric acid and enzyme pepsin. If mucus is not released, it will lead to erosion of inner lining of stomach, leading to acidity and ulcers.
52. Fats are present in food in the form of large globules which makes it difficult for enzymes to act on them. Bile salts present in bile break them down mechanically into smaller globules which increases the efficiency of fat digesting enzymes.
53. The wall of alimentary canal contains muscle layers. Rhythmic contraction and relaxation of these muscles pushes the food forward. This is called peristalsis, which occurs all along the gut.
54. Maximum absorption occurs in small intestine because
- (a) digestion is completed in small intestine
- (b) inner lining of small intestine is provided with villi which increases the surface area for absorption.
- (c) wall of intestine is richly supplied with blood vessels (which take the absorbed food to each and every cell of the body).

55. (a) — (iv) (b) — (iii)
(c) — (i) (d) — (ii)
56. Aquatic organisms like fishes obtain oxygen from water present in dissolved state through their gills. Since the amount of dissolved oxygen is fairly low compared to the amount of oxygen in the air, the rate of breathing in aquatic organisms is much faster than that seen in terrestrial organisms.
57. The blood circulation in human heart is called double circulation because the blood passes through the heart twice in one complete cycle of the body – once through the right half in the form of deoxygenated blood and once through the left half in the form of oxygenated blood.
58. In four chambered heart, left half is completely separated from right half by septa. This prevents oxygenated and deoxygenated blood from mixing. This allows a highly efficient supply of oxygenated blood to all parts of the body. This is useful in animals that have high energy needs, such as birds and mammals.
59. The major events during photosynthesis are
(a) absorption of light energy by chlorophyll
(b) conversion of light energy to chemical energy
(c) splitting of H_2O into H_2 , O_2 and e^-
(d) reduction of CO_2 to carbohydrates
60. (a) Decreases
(b) Decreases
(c) Increases
(d) Decreases
61. Adenosine triphosphate (ATP) produced during respiration in living organisms and also during photosynthesis in plants.
62. All are parasites, they derive nutrition from plants or animals without killing them.
63. (a) Food is crushed into small pieces by the teeth.
(b) It mixes with saliva and the enzyme amylase (found in saliva) breaks down starch into sugars.
(c) Tongue helps in thorough mixing of food with saliva.
64. (a) Production of pepsin enzyme that digests proteins
(b) Secretion of Mucus for protection of inner lining of stomach.
65. (a) — i, (b) — iv, (c) — ii, (d) — iii

66. (a)— Protein (b)— Starch (c)— Protein (d)— Fats
67. Arteries carry blood from the heart to various organs of the body under high pressure so they have thick and elastic walls. Veins collect the blood from different organs and bring it back to the heart. The blood is no longer under pressure so the walls are thin with valves to ensure that blood flows only in one direction.
68. In the absence of platelets, the process of clotting will be affected.
69. Plants do not move. In a large plant body there are many dead cells like schlerenchyma as a result it requires less energy as compared to animals.
70. Cells of root are in close contact with soil and so actively take up ions. The ion-concentration, increases inside the root and hence osmotic pressure increases the movement of water from the soil into the root which occurs continuously.
71. Transpiration is important because
- (a) it helps in absorption and upward movement of water and minerals from roots to leaves
 - (b) it prevents the plant parts from heating up.
72. Many plants store waste materials in the vacuoles of mesophyll cells and epidermal cells. When old leaves fall, the waste materials are excreted along with the leaves.

Long Answer Questions

73. **Hints—** Finger like projections
Food vacuoles
Diffusion of simpler substances.
74. **Hints—** Mouth cavity
Oesophagus
Stomach
Intestine
75. **Hints—** 1. Passage of air
2. Gaseous exchange
3. Role of diaphragm
4. Function of rib muscles and alveoli
76. **Hints—** 1. Anchoring the plant
2. Source of water and minerals
3. Availability of oxygen for respiration of root cells
4. Symbiotic association with microbes

77.

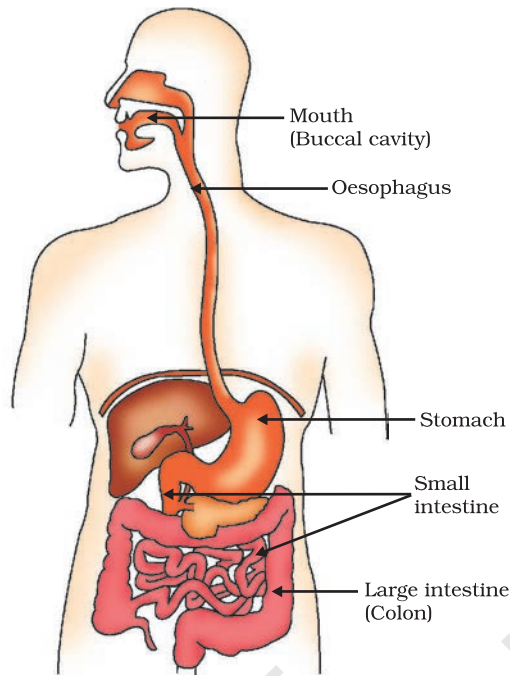

Alimentary canal of man

78. **Hints**— Mouth cavity
Stomach
Intestine

79. **Hints**— Absorption of light energy by chlorophyll
Conversion of light energy into chemical energy
Reduction of CO_2 into carbohydrates.

80. **Hints**— Pyruvate to ethanol, CO_2 and energy
Pyruvate to lactic acid and energy
Pyruvate to CO_2 , H_2O and energy

81. **Hints**— Atrium
Ventricles
Oxygenated blood
De-oxygenated blood

82. **Hints**— Nephrons
Filtration
Selective reabsorption

CHAPTER 7

ANSWERS

Multiple Choice Questions

- | | | | |
|---------|---------|---------|---------|
| 1. (a) | 2. (c) | 3. (d) | 4. (b) |
| 5. (d) | 6. (c) | 7. (c) | 8. (b) |
| 9. (b) | 10. (d) | 11. (c) | 12. (d) |
| 13. (b) | 14. (b) | 15. (a) | 16. (c) |
| 17. (c) | 18. (b) | 19. (a) | 20. (c) |
| 21. (b) | 22. (c) | 23. (d) | 24. (b) |
| 25. (c) | 26. (a) | 27. (b) | 28. (c) |
| 29. (d) | 30. (b) | 31. (c) | 32. (d) |
| 33. (d) | | | |

Short Answer Questions

34. (a) Sensory neuron
(b) Spinal cord (CNS)
(c) Motor neuron
(d) Effector = Muscle in arm
35. (a) Auxin
(b) Gibberellin
(c) Cytokinin
(d) Abscisic acid
36. (a) Pineal gland
(b) Pituitary gland
(c) Thyroid
(d) Thymus
37. Figure (a) is more appropriate because in a plant shoots are negatively geotropic hence, grow upwards and roots are positively geotropic so grow downwards.

38. (a) Dendrite
(b) Cell body
(c) Axon
(d) Nerve ending
39. (a) — (iii) (b) — (iv)
(c) — (i) (d) — (ii)
40. The directional growth movements of plants due to external stimuli are called tropic movement. It can be either towards the stimulus, or away from it. For example, in case of phototropic movement, shoots respond by bending towards light while roots respond by bending away from it.
41. (a) When iodine intake is low, release of thyroxin from thyroid gland will be less by which protein, carbohydrate and fat metabolisms will be affected.
(b) A person might suffer from goitre in case of iodine deficiency in the body.
42. When an electrical signal reaches the axonal end of one neuron it releases certain chemical substances that cross the synapse and move towards the dendritic end of next neuron generating another electrical signal.
43. (a) Oestrogen
(b) Growth hormone
(c) Insulin
(d) Thyroxin
44. (a) Pituitary
(b) Pancreas
(c) Adrenal
(d) Testes

Long Answer Questions

45. **Hints**— Cell body
Dendrite
Axon
46. **Hints**— Fore brain
Mid brain
Hind brain
Give its functions

47. Hints— Brain and spinal cord

Brain box and vertebral column.

- 48.** (a) Thyroxin regulates carbohydrate, fat and protein metabolisms
(b) Insulin — regulates blood sugar
(c) Adrenaline — increases heart rate and supply of blood to various organs
(d) Growth hormone — regulates growth and development
(e) Testosterone — controls the changes of body features associated with puberty in male

49. Hints— Auxin

Gibberellin
Cytokinin
Abscisic acid

50. Hints— Definition

Nerve impulses

51. Hints— Nerve impulses

Dendritic end and axonal end
Role of hormones
Roles of blood, muscles and glands.

- 52.** Different endocrine glands secrete different hormones. These hormones are released into blood which carry them to specific tissues or organs called target tissues or target organs. In the target tissues, hormone triggers a particular biochemical or physiological activity.

- 53.** When an electrical signal reaches the axonal end of a neuron, it releases a chemical substance. This chemical diffuses towards the dendrite end of next neuron where it generates an electrical impulse or signal. Hence, the electrical signal is converted into a chemical signal at the axonal end. Since these chemicals are absent at the dendrite end of the neuron the electrical signal, cannot be converted into chemical signal.



CHAPTER 8

ANSWERS

Multiple Choice Questions

- | | | | |
|---------|---------|---------|---------|
| 1. (b) | 2. (c) | 3. (c) | 4. (a) |
| 5. (d) | 6. (c) | 7. (a) | 8. (a) |
| 9. (d) | 10. (a) | 11. (b) | 12. (b) |
| 13. (b) | 14. (c) | 15. (b) | 16. (d) |
| 17. (b) | 18. (c) | 19. (c) | 20. (b) |
| 21. (d) | 22. (c) | 23. (d) | 24. (b) |
| 25. (c) | 26. (a) | 27. (b) | |

Short Answer Questions

28. The pistil is intact. Cross pollination has occurred leading to fertilisation and formation of fruit.
29. Yes, because it results in the formation of two daughter cells, that is, it results in the production of more individuals of the organism.
30. Clone refers to offspring of an organism formed by asexual method of reproduction. Since they possess exact copies of the DNA of their parent, clones exhibit remarkable similarity.
31. Reduction division (meiosis) during gamete formation halves the chromosome number in both male and female gametes. Since these two gametes fuse during fertilisation, the original number of chromosomes (as in the parent) is restored in the offspring.
32. Sugar provides energy for sustaining all life activities in yeasts. In water, it fails to reproduce because of inadequate energy in its cells.
33. Moisture is an important factor for the growth of hyphae. Moistened bread slice offers both moisture and nutrients to the bread mould, hence it grows profusely. Dry slice of bread offers nutrients but not moisture hence hyphae fail to grow.

- 34.** (a) Sexual reproduction involves two parents with different sets of characters
(b) The gene combinations are different in gametes.

35. Yes, shaded part in Figures D and E represent the regenerated halves.

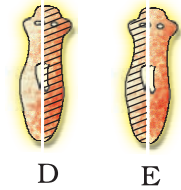

- 36.** (a) No, there is no relationship between size of organism and its chromosome number.
(b) No, process of reproduction follows a common pattern and is not dependent on the number of chromosomes
(c) Yes, since the major component of chromosome is DNA, if there are more chromosomes in a cell, the quantity of DNA will also be more.

37. Number of chromosomes in female gamete is 24
Number of chromosomes in zygote is 48

38. In a flower fertilisation requires both male and female gametes.
If pollination does not occur, male gamete is not available hence fertilisation cannot take place.

39. Yes, the constancy is maintained because cells in all these three structures undergo only mitotic divisions.

40. Zygote is located inside the ovule which is present in the ovary.

41. In reproduction, DNA passes from one generation to the next. Copying of a DNA takes place with consistency but with minor variations. This consistency leads to stability of species.

42. General growth refers to different types of developmental process in the body like increase in height, weight gain, changes in shape and size of the body but sexual maturation is specific to changes reflected at puberty like cracking of voice, new hair patterns, development of breast in female etc.

43. Sperm comes out from testis into the vas deferens and then passes through urethra before ejaculation. The secretions of seminal vesicle and prostate glands provide nutrition to the sperms and also facilitate their transport.

44. The thick and spongy lining of the uterus slowly breaks and comes out through the vagina as blood and mucus.

45. The uterine wall thickens that is richly supplied with blood. A special tissue called placenta develops which connects embryo to the uterine wall that provides nutrients and oxygen to it.

46. Mechanical barriers like condom prevents the sperms from reaching the egg. Thus it is an effective method to avoid pregnancy. It also prevents transmission of infections during sexual act.

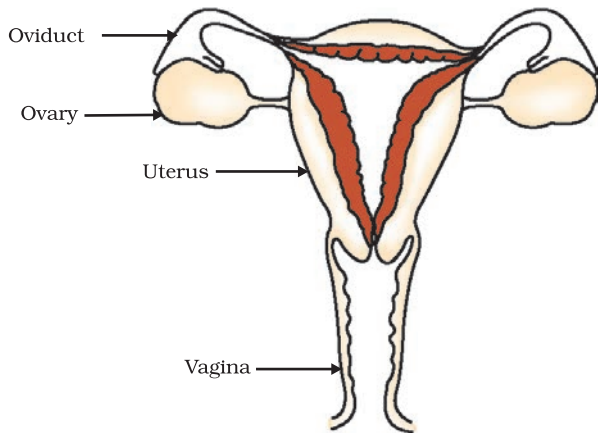

47. (a) Ovary (production of egg)
 (b) Oviduct (site of fertilisation)
 (c) Uterus (site of implantation)
 (d) Vagina (entry of the sperms)

48. The ratio is 1 : 2. Sperms contain either X or Y chromosome whereas an egg will always have an X chromosome.

Long Answer Questions

49. Budding, fragmentation and regeneration are considered as asexual types of reproduction because all of them involve only one parent and gametes are not involved in reproduction

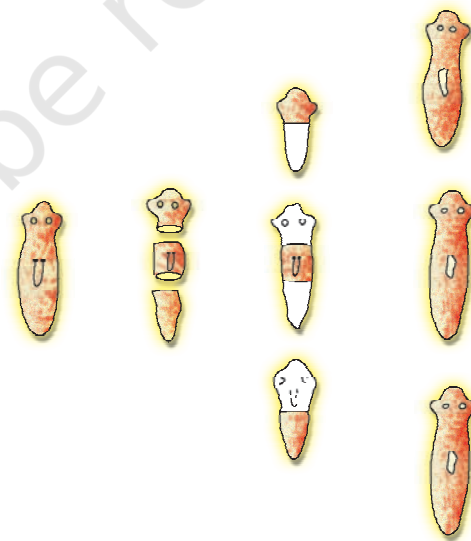

Regeneration in Planaria

50.

Asexual reproduction	Sexual reproduction
(a) Involves only one parent	(i) Often involves two parents
(b) Gametes are not produced	(ii) Gametes are produced
(c) No fertilisation and zygote formation	(iii) Fertilisation and zygote formation is observed.
(d) Meiosis does not occur at anytime during reproduction	(iv) Meiosis occurs at the time of gamete formation

During sexual reproduction two types of gametes fuse. Although the gametes contain the same number of chromosomes, their DNA is not identical. This situation generates variations among the offsprings.

51. The process or mechanism of transfer of pollen grains from the anther to the stigma is termed pollination.

The fusion of male and female gametes giving rise to zygote is termed fertilisation

The site of fertilisation is ovule.

The product of fertilisation is zygote.

52. Gamete represents the sex cell or germ cell in sexual reproduction. There are two types of gametes, male and female.

Zygote is the product of fertilisation in which a male and a female gamete fuse with each other.

The two fusing gametes possess characters of their parents in their DNA. Fertilisation brings characters of both parents into one zygote cell.

Zygote is the first cell of the next generation. It divides to form an embryo which subsequently grows into a new individual.

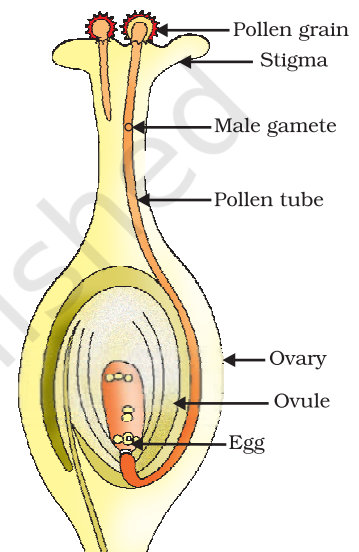

Pollen tube growth and its entry into the ovule

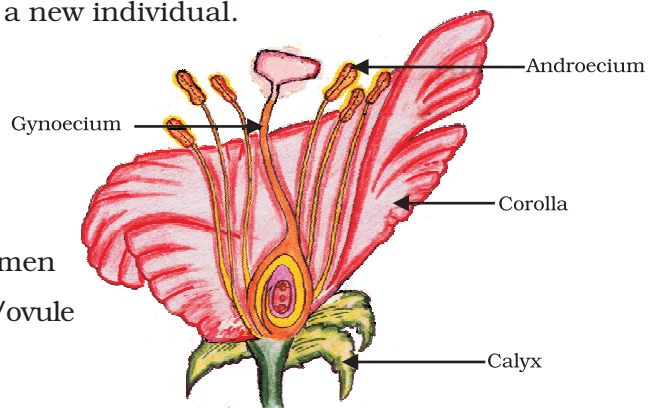

Male gamete forming part – anther/stamen

Female gamete forming part – pistil/ovary/ovule

53.

54. Hints—

- (a) Special tissue connection between embryo and uterine wall
- (b) Possesses villi that increases the surface area.
- (c) Facilitate passage of nutrition and oxygen to embryo from mother through blood.
- (d) Waste substances produced by embryo are removed through placenta into mother's blood.

55. Hints—

- (a) Contraceptive methods are used such as (i) mechanical (ii) drugs (as pills) (iii) loop or copper T and (iv) surgical method.
- (b) Pills change the hormonal balance and thus prevent the release of egg, hence fertilisation is prevented.

56. Hints—

- (a) Sperm enters through the vaginal passage during sexual intercourse and moves upwards.
- (b) Egg released from the ovary reaches the oviduct.
- (c) Sperm encounters egg in the oviduct and fertilization takes place.
- (d) Egg is released once every month by ovary.

57. Hints—

- (a) Organisms need energy for survival which they obtain from life processes such as nutrition and respiration.
- (b) Reproduction needs a lot of energy.
- (c) Genetic material is transferred from one generation to the next as a result of reproduction through DNA copying.
- (d) DNA copying takes place with high constancy and considerable variations, that is, advantages to the species for stability in the changing environment.

58. Hints—

- (a) These are infectious diseases transmitted during sexual contact.
- (b) They may be bacterial like or viral like.
- (c) Use of mechanical barrier like condom prevents transmission of infection.



CHAPTER 9

ANSWERS

Multiple Choice Questions

- | | | | |
|---------|---------|---------|---------|
| 1. (c) | 2. (b) | 3. (a) | 4. (d) |
| 5. (a) | 6. (c) | 7. (b) | 8. (b) |
| 9. (b) | 10. (a) | 11. (b) | 12. (c) |
| 13. (a) | 14. (b) | 15. (a) | 16. (c) |
| 17. (a) | 18. (b) | 19. (c) | 20. (a) |
| 21. (b) | 22. (c) | 23. (a) | 24. (b) |
| 25. (d) | | | |

Short Answer Questions

26. The sex of the individual is genetically determined i.e., genes inherited from parents decide whether the new born will be a boy or a girl. A new born who inherits an 'X' chromosome from father will be a girl and one who inherits a 'Y' chromosome will be a boy.
27. No, because mothers have a pair of X-chromosomes. All children will inherit an 'X' chromosome from their mother regardless of whether they are boys or girls.
28. (a) Fossils represent modes of preservation of ancient species.
(b) Fossils help in establishing evolutionary traits among organisms and their ancestors.
(c) Fossils help in establishing the time period in which organisms lived.
29. Human females have two X chromosomes called sex chromosomes. During meiosis at the time of gamete formation, one X chromosome enters each gamete. Hence all the gametes possess an X chromosome.
30. The sex of an infant is determined by the type of sex chromosome contributed by the male gamete. Since the ratio of male gametes containing X chromosome and those containing Y chromosome is 50 : 50, the statistical probability of male or a female infant is also 50 : 50.

- 31.** Fewer individuals in a species impose extensive inbreeding among them. This limits the appearance of variations and puts the species at a disadvantage if there are changes in the environment. Since the individuals fail to cope up with the environmental changes, they may become extinct.
- 32.** Structures which have a common basic structure but perform different functions are called homologous structures. e.g. fore limbs of reptiles, amphibians and mammals. Yes, they have common ancestor but variously modified to carry out different activities.
- 33.** Though animals have a vast diversity in structures they probably do not have a common ancestry, because common ancestry may greatly limit the extent of diversity. As many of these diverse animals are inhabiting the same habitat, their evolution by geographical isolation and speciation is also not likely. Thus, a common ancestry for all the animals is not the likely theory.
- 34.** (a) yellow — dominant
green — recessive
(b) round — dominant
wrinkled — recessive
- 35.** (a) Easy to grow
(b) Short life span
(c) Easily distinguishable characters
(d) Larger size of flower
(e) Self pollinated
- 36.** ((a) The woman produces ova with 'X' chromosome
(b) The man produces sperms with X and Y chromosome which actually determines the sex of the baby.

Long Answer Questions

- 37.** Yes, geographical isolation gradually leads to genetic drift. This may impose limitations to sexual reproduction of the separated population. Slowly the separated individuals will reproduce among themselves and generate new variations. Continuous accumulation of those variations through a few generations may ultimately lead to the formation of a new species.
- 38.** This is a debatable issue. If appearance of complexity is concurrent with evolution then, human beings are certainly more evolved than bacteria. But if we take the totality of life characteristics into account, then it is hard to label either organism as evolved.

39. Hints— Common body plan, structure, physiology and metabolism.

Constant chromosome number

Common genetic blue print

Freely inter-breeding

40. Characters that are passed on from parents to offspring are inherited characters e.g., colour of seeds, colour of eyes.

Characters appearing in an individual's life time but cannot be transmitted to next generation are acquired characters e.g., obese body, loss of a finger in an accident.

41. Acquired characters do not produce change in the DNA of germ cells, so they cannot be inherited. Only those characters which have a gene for them can be inherited.

42. We see immense diversity in size, form, structure and morphological features in the living world. But at the molecular level these, diverse types of organisms exhibit unbelievable similarity. For instance, the basic biomolecules like DNA, RNA, carbohydrates, proteins etc. exhibit remarkable similarity in all organisms.

43. (a) Round, yellow

(b) Round, yellow

Round, green

Wrinkled, yellow

Wrinkled, green

(c) Wrinkled, green

(d) Round, yellow

44. Rr Yy Round, yellow

45. (i) Round yellow — 9 (ii) Round green — 3

(iii) Wrinkled yellow — 3 (iv) Wrinkled green — 1

9 : 3 : 3 : 1

46. (i) Characters are controlled by genes.

(ii) Each gene controls one character

(iii) There may be two or more forms of the gene

(iv) One form may be dominant over the other

(v) Genes are present on chromosomes

(vi) An individual has two forms of the gene whether similar or dissimilar

(vii) The two forms separate at the time of gamete formation

(viii) The two forms are brought together in the zygote

47. The tall/short and round/wrinkled seed trait are independently inherited.

CHAPTER 10

ANSWERS

Multiple Choice Questions

- | | | | |
|---------|---------|---------|---------|
| 1. (a) | 2. (b) | 3. (c) | 4. (a) |
| 5. (a) | 6. (a) | 7. (d) | 8. (a) |
| 9. (a) | 10. (b) | 11. (b) | 12. (b) |
| 13. (d) | 14. (b) | 15. (d) | 16. (d) |
| 17. (a) | 18. (c) | 19. (d) | |

Short Answer Questions

20. (a) concave mirror
(b) convex lens
(c) concave lens
(d) convex mirror
21. **Hint**— Draw the diagram and explain using laws of refractions at both the interfaces.
22. **Hint**— No. Bending will be different in different liquids since velocity of light at the interface separating two media depends on the relative refractive index of the medium.
23. **Hint**— $n = \frac{c}{v}$
 $n_{21} = \frac{v_1}{v_2}$
24. **Hint**— $n_{dg} = \frac{v_g}{v_d} = 1.6$, $n_g = \frac{c}{v_g}$, and $n_d = \frac{c}{v_d}$
- Therefore, $\frac{v_g}{v_d} \times \frac{c}{v_g} = n_d = 1.6 \times 1.5 = 2.40$.
25. **Hint**— Statement is correct if the object is placed within 20 cm from the lens in the first case and between 20 cm and 40 cm in the second case.

26. **Hint**— Sudha should move the screen towards the lens so as to obtain a clear image of the building. The approximate focal length of this lens will be 15 cm.

27. $P = \frac{1}{f}$, $P \propto \frac{1}{f}$. Power of a lens is inversely proportional to its focal length therefore lens having focal length of 20 cm will provide more convergence.

28. When two plane mirrors are placed at right angle to each other then the incident and reflected rays will always be parallel to each other.

29. **Hint**—

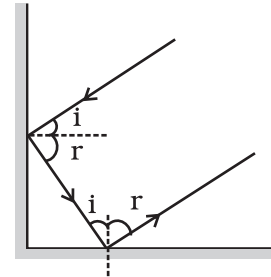
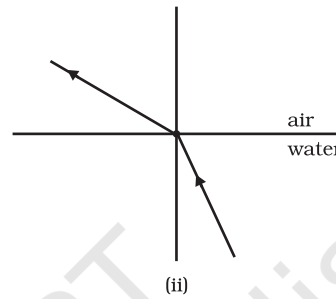
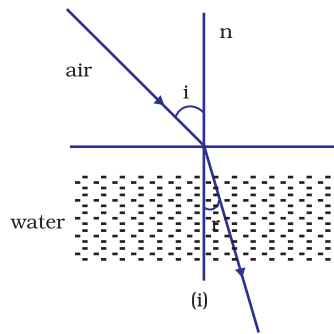

Long Answer Questions

30. **Hint**— Draw ray diagrams separately indicating the direction of incident and reflected rays.

31. **Hint**— Draw ray diagrams separately indicating the direction of incident.

32. **Hint**— Draw ray diagrams indicating the direction of incident, refracted and emergent rays and explain.

33. **Hint**— Draw ray diagrams separately indicating the direction of incident and refracted rays.

34. **Hint**— Draw ray diagrams indicating the direction of incident ray and reflected ray.

35. **Hint**— $m = -\frac{v}{u} = -3$, using $\frac{1}{v} - \frac{1}{u} = \frac{1}{f}$ calculate u .

$u = -\frac{80}{3}$ cm, image is real and inverted. The lens is convex.

36. $m = \frac{1}{3}$. Using $\frac{1}{v} + \frac{1}{u} = \frac{1}{f}$ calculate u ; $u = -80$ cm. Image is real and inverted. Mirror is concave.

37. **Hint** — $P = \frac{1}{f}$ where f is in metre. Its unit is Dioptre. Lens is convex in the first case and concave in the second case. Power is equal to 2 dioptre in the first case and -2 dioptre in the second case.

38. **Hint**—

(i) Focal length = $\frac{38}{2} = 19$ cm

(ii) The image will be formed at infinity

(iii) Virtual and erect

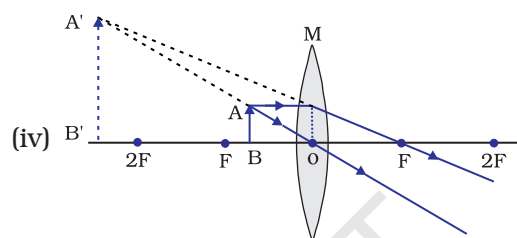

CHAPTER 11

ANSWERS

Multiple Choice Questions

- | | | | |
|---------|---------|---------|---------|
| 1. (b) | 2. (a) | 3. (b) | 4. (a) |
| 5. (c) | 6. (b) | 7. (c) | 8. (c) |
| 9. (b) | 10. (b) | 11. (c) | 12. (b) |
| 13. (a) | 14. (c) | | |

Short Answer Questions

15.

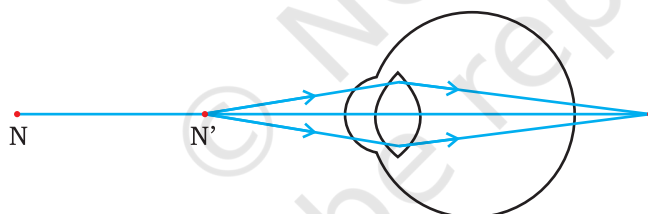
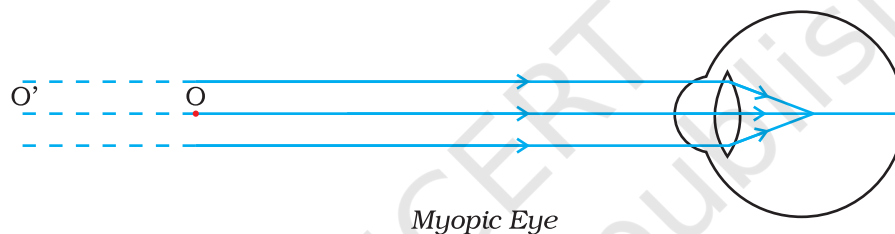

16. **Hint**— The student is suffering from myopia (near sightedness). Doctor advises her to use a concave lens of appropriate power to correct this defect.

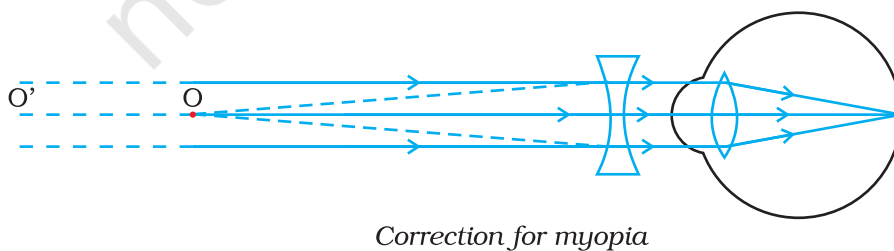

17. **Hint**— Human eye is able to see nearby and distant objects clearly by changing the focal length of the eye lens using its power of accommodation

18. (a) Myopia

(b) **Hint**— $f = \frac{1}{-4.5} = -\frac{2}{9} = -0.22 \text{ m}$,

(c) Concave lens

19. **Hint**— By using two identical prisms, one placed inverted with respect to the other.

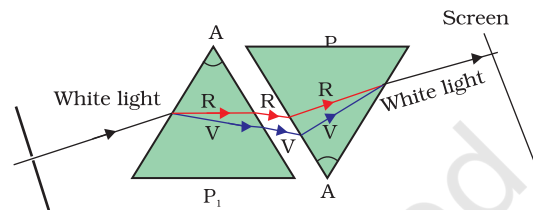

20.

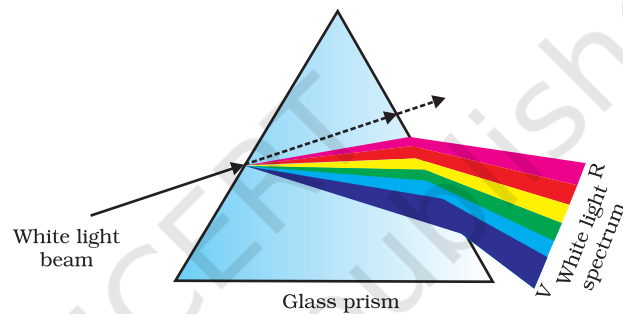

21. No. light from stars undergoes atmospheric refraction which occurs in medium of gradually changing refractive index.

22. **Hint**— The water droplets behave like prisms and disperse sunlight.

23. **Hint**— Blue colour gets scattered the maximum.

24. **Hint**— During sunrise and sunset the sun appears reddish whereas at noon the sun appears white. Explanation should be given in terms of atmospheric depth travelled by light. Colours are different due to scattering of light by atmospheric particles.

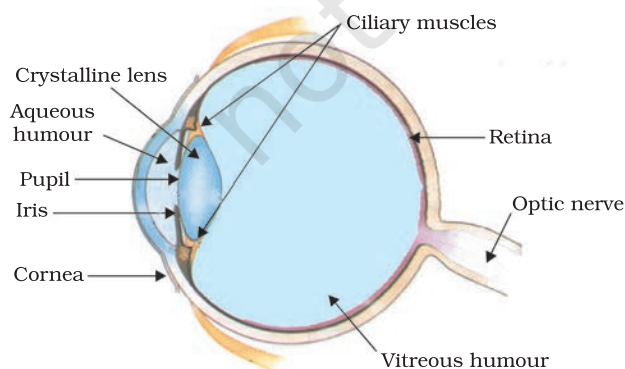

Long Answer Questions

25. **Hint**— Give explanation of each part and discuss power of accommodation.

26. **Hint**— When a person is not able to see distant objects clearly but can see nearby objects clearly then he is considered to be myopic. If it is otherwise, he is hypermetropic. Give explanation based on figures.
27. Give explanation based on Figure. Angle of deviation is the angle D, between the incident ray and the emergent ray when a ray of light passes through a glass prism.

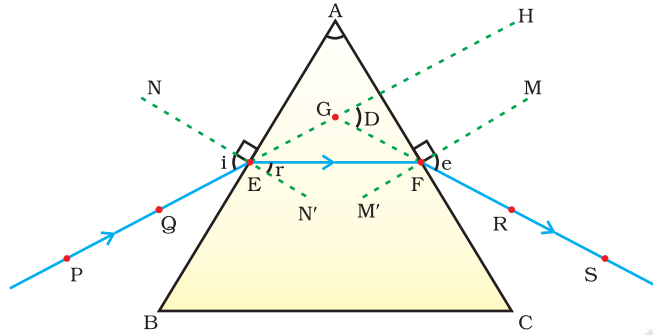

28. **Hint**— Sun appears reddish at sunrise or sunset as blue light gets scattered away.

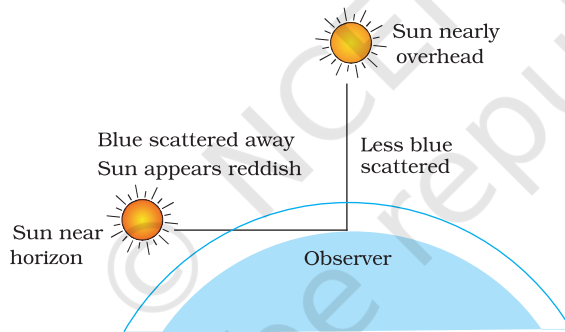

29. Give explanation using the Figure.

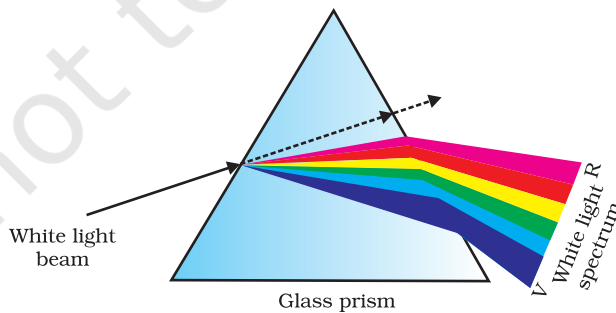

30. **Hint**— Give explanation using the Figure. Planets do not twinkle as they are closer to earth and are seen as extended sources.

CHAPTER 12

ANSWERS

Multiple Choice Questions

- | | | | |
|---------|---------|---------|---------|
| 1. (d) | 2. (a) | 3. (d) | 4. (a) |
| 5. (b) | 6. (d) | 7. (b) | 8. (a) |
| 9. (a) | 10. (c) | 11. (c) | 12. (c) |
| 13. (c) | 14. (c) | 15. (c) | 16. (d) |
| 17. (b) | 18. (a) | | |

Short Answer Questions

19.

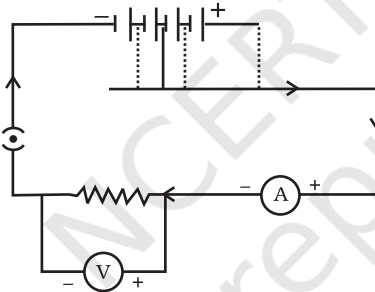

20. Maximum current through resistor A = $\sqrt{\frac{18}{2}}$ A = 3 A.

Thus the maximum current through resistors B and C each

$$3 \times \frac{1}{2} \text{ A} = 1.5 \text{ A}.$$

21. **Hint**— It should be as close to zero as possible. Ideally it should be zero ohm. If it is non-zero and substantial it will affect the true current.

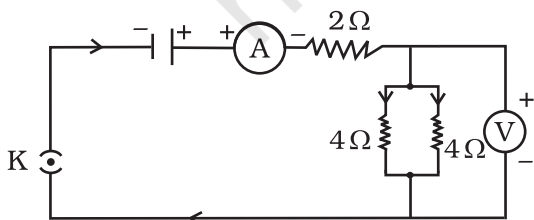

22. **Hint**— Yes. Total resistance of the parallel combination is also 2 ohm (2 Ω).

- 23. Hint—** If a current larger than a specified value flows in a circuit, temperature of fuse wire increases to its melting point. The fuse wire melts and the circuit breaks.
- 24. Hint—** Use the formula $R = \rho \frac{l}{A}$. Also, $V = RI$. R is doubled while V remains unchanged. Hence current becomes $\frac{I}{2}$.
- 25.** kW h. $1 \text{ kW h} = 1000 \text{ W} \times 60 \times 60 \text{ s} = 3.6 \times 10^6 \text{ J}$
- 26.** (i) 5Ω (ii) **Hint—** Calculate the total resistance of the circuit. There will be no change in current flowing through 5Ω conductor. Also there will be no change in potential difference across the lamp either.
- 27. Hint—** Provide the same potential difference across each electrical appliance.
- 28. Hint—** (i) The glow of the bulbs B_2 and B_3 will remain the same.
(ii) A_1 shows 1 ampere, A_2 shows zero, A_3 shows 1 ampere and A shows 2 ampere
(iii) $P = V \times I = 4.5 \times 3 = 13.5 \text{ W}$

Long Answer Questions

- 29.** (a) No. The resistance of the bulbs in series will be three times the resistance of single bulb. Therefore, the current in the series combination will be one-third compared to current in each bulb in parallel combination. The parallel combination bulbs will glow more brightly.
- (b) The bulbs in series combination will stop glowing as the circuit is broken and current is zero. However the bulbs in parallel combination shall continue to glow with the same brightness.
- 30. Hint—** Define Ohm's law. Give details of experiment using a labelled circuit diagram. Support your answer giving relation between V and I and a graph depicting Ohm's law. Ohm's law does not hold under all conditions. Mention the conditions.
- 31. Hint—** Resistivity is numerically equal to the resistance of a wire of unit length having an unit area of cross-section. Its unit is ohm metre ($\Omega \text{ m}$). Mention the dependence of resistance on length and area of cross section of the wire giving details of experiment using a circuit diagram.
- 32. Hint—** Describe the experiment using a circuit diagram. Give details showing that same current flows through each component in a series circuit.

33. Hint— Describe the experiment using a circuit diagram. Give details showing that same potential difference exists across each resistance in a parallel circuit.

34. Hint— Joule's heating effect, $H = I^2Rt$. Describe the experiment using a circuit diagram. Applications: electric heater, geyser, laundry iron, electric oven, bulb, toaster, kettle etc.

35. (a) 4 Ω . Hint— $R = R_1 R_2 / (R_1 + R_2) = \left(\frac{8 \times 8}{8 + 8} \right) = 4 \Omega$

(b) 1 A. **Hint—** $I = V/R = 8/(4 + \left(\frac{8 \times 8}{8 + 8} \right)) = 8/8 = 1A$

(c) 4 V. **Hint—** $V = IR = 1 \times 4 = 4 V$

(d) 4 W. **Hint—** $P = I^2R = 1^2 \times 4 = 4 W$

(e) No difference.

Hint— Same current flows through each element in a series circuit.



CHAPTER 13

ANSWERS

Multiple Choice Questions

1. (c) 2. (c) **Hint**— Only earth's magnetic field will be present.
3. (a) **Hint**— Misconception is that magnetic field lines point from north to south pole. The fact is that they emerge out of North pole and enter into South pole.
4. (c) 5. (a) 6. (c) 7. (d)
8. (d) AC frequency in India is 50 Hz. The direction changes twice in each cycle so that change of direction takes place after every $\frac{1}{100}$ second.
9. (b) 10. (c) 11. (a) 12. (b)

Short Answer Questions

13. In the plane of the paper itself. The axis of the compass is vertical and the field due to the conductor is also vertical. It could result in a dip of compass needle which is not possible in this case (dips result only if axis of compass is horizontal). The deflection is maximum when the conductor through A is perpendicular to the plane of paper and the field due to it is maximum in the plane of the paper.
14. **Hint**— (i) The current through the solenoid should be direct current.
(ii) The rod inside is made of a magnetic material such as steel.
15. *Into* the plane of paper at P and *out* of it at Q. The strength of the magnetic field is larger at the point located closer i.e. at Q.
16. The deflection increases. The strength of magnetic field is directly proportional to the magnitude of current passing through the straight conductor.
17. **Hint**— (i) Yes, Alpha particles being positively charged constitute a current in the direction of motion. (ii) No. The neutrons being electrically neutral constitute no current.

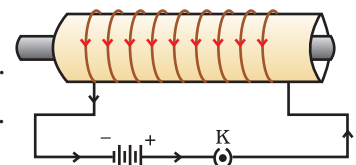

18. The thumb indicates the direction of current in the straight conductor held by curled fingers, whereas the Fleming's left-hand rule gives the direction of force experienced by current carrying conductor placed in an external magnetic field.
19. Strength of the magnetic field falls as distance increases. This is indicated by the decrease in degree of closeness of the lines of field.
20. The divergence, that is, the falling degree of closeness of magnetic field lines indicates the fall in strength of magnetic field near and beyond the ends of the solenoid.
21. Electric fans, mixers, washing machines, computer drives, etc. Motors convert electrical energy into mechanical energy whereas generators convert mechanical energy into electrical energy.
22. The brushes are connected to the battery and touch the outer side of two halves of the split ring whose inner sides are insulated and attached to the axle.
23. Direct current always flows in one direction but the alternating current reverses its direction periodically. The frequency of AC in India is 50 Hz and in each cycle it alters direction twice. Therefore AC changes direction $2 \times 50 = 100$ times in one second.
24. Fuse is used for protecting appliances due to short-circuiting or overloading. The fuse is rated for a certain maximum current and blows off when a current more than the rated value flows through it. If a fuse is replaced by one with larger ratings, the appliances may get damaged while the protecting fuse does not burn off. This practice of using fuse of improper rating should always be avoided.

Long Answer Questions

25. Current carrying loops behave like bar magnets and both have their associated lines of field. This modifies the already existing earth's magnetic field and a deflection results. Magnetic field has both direction and magnitude. Magnetic field lines emerge from N-pole and enter S-pole. The magnetic field strength is represented diagrammatically by the degree of closeness of the field lines. Field lines cannot cross each other as two values of net field at a single point cannot exist.

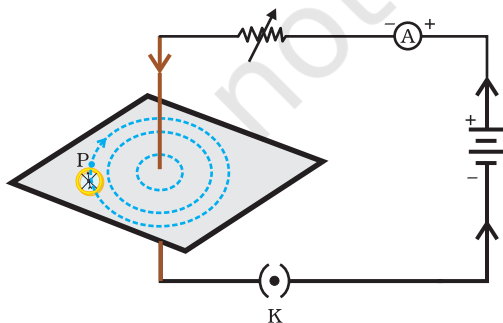

Only one value, a unique net value, can exist. If in a given region, lines of field are shown to be parallel and equi-spaced, the field is understood to be uniform.

26. Right hand thumb rule states that if a current carrying straight conductor is supposedly held in the right hand with the thumb pointing towards the direction of current, then the fingers will wrap around the conductor in the direction of the field lines of the magnetic field.

27. **Hint**— The magnetic field at a point is the addition of the field produced by each turn.

28. **Hint**— Explain the activity with the help of the diagram. According to Fleming's left hand rule, stretch the thumb, forefinger and central finger of your left hand such that they are mutually perpendicular. If the fore finger points in the direction of magnetic field and the central in the direction of current, then the thumb will point in the direction of motion or force acting on the conductor.

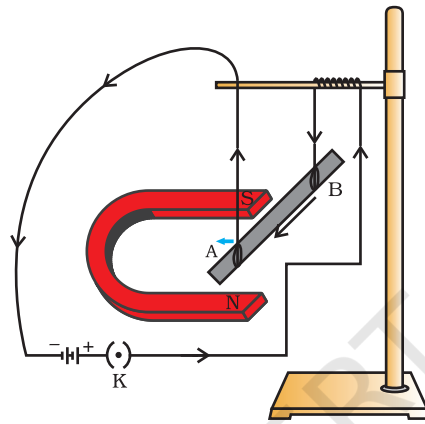
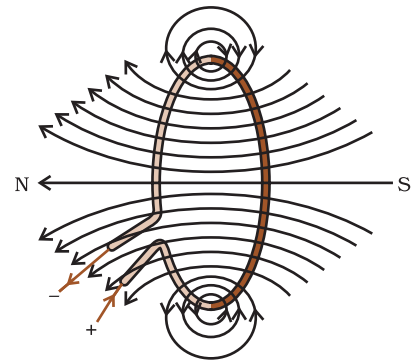

29. **Hint**— Explain working with the help of the diagram. Commercial motors use an electromagnet in place of a permanent magnet, a large number of turns of conducting wire in the current carrying coil and a soft iron core on which the coil is wound.

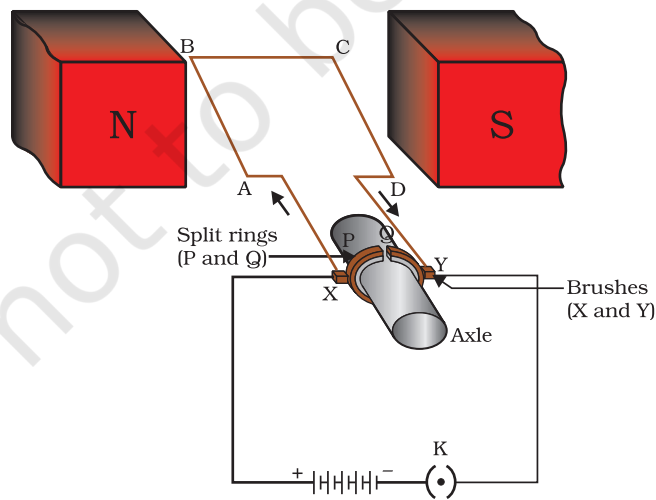

- 30. Hint—** The process by which a changing magnetic field in a conductor induces a current in another conductor is called electromagnetic induction.

Explain the working of the set up with the help of the diagram.

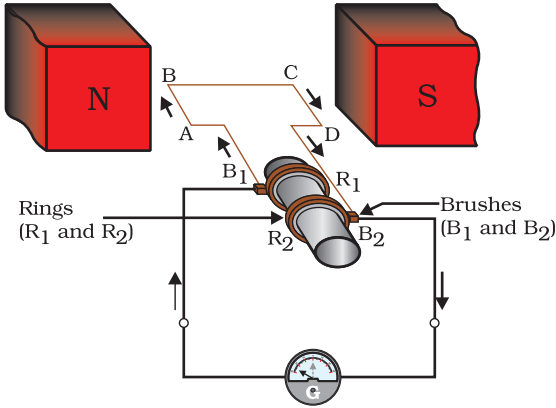
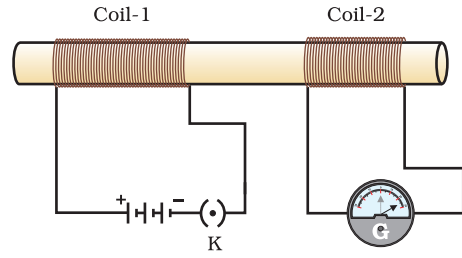

- 31.** Explain working with the help of the diagram. To get a direct current a split ring type commutator must be used in place of slip ring type commutator.

- 32. Hint—**

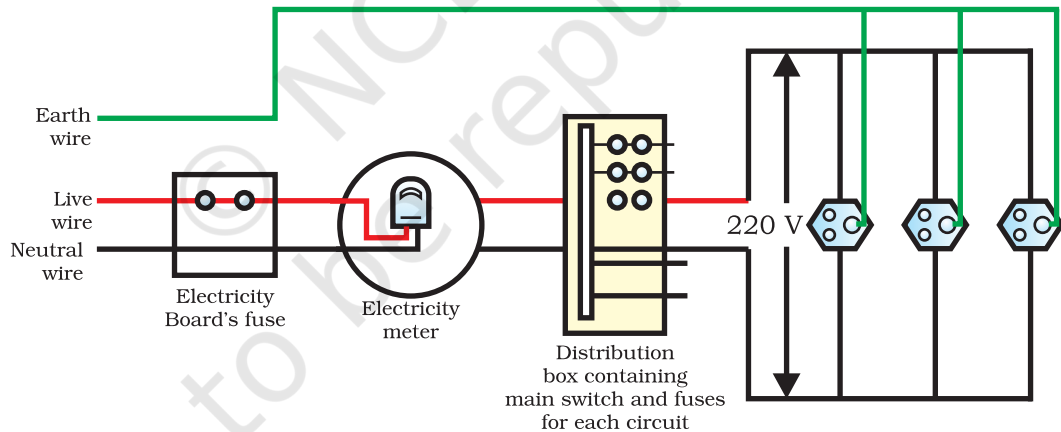

A fuse in a circuit prevents damage to the appliances and the circuit due to overloading. Otherwise the appliances or the circuit may get damaged.

CHAPTER 14

ANSWERS

Multiple Choice Questions

- | | | | |
|---------|---------|---------|---------|
| 1. (c) | 2. (b) | 3. (d) | 4. (a) |
| 5. (b) | 6. (c) | 7. (b) | 8. (c) |
| 9. (c) | 10. (a) | 11. (c) | 12. (a) |
| 13. (b) | 14. (b) | 15. (c) | |

Short Answer Questions

16. **Hint—** (i) Our demand for energy is increasing to improve quality of life and growth of population. (ii) Fossil fuels are limited.
17. **Hint—** Tidal, Wave, OTEC etc.
18. (i) Use of smokeless appliances.
(ii) Afforestation
19. **Hint—** Plane mirror acts as a reflector,
Glass sheet results in green house effect.
20. **Hint—** (i) Solar cells have no moving parts
(ii) Requires little maintenance
(iii) They can be set up in remote areas
21. **Hint—** Biomass: Plant and animal wastes. Explain the working of a biogas plant with a labelled diagram.
22. Because of it being erratic, energy cannot be harnessed continuously. Large areas are required for wind farms.

Long Answer Questions

23. **Hint—** Nuclear Fission. Explanation must include all the steps starting from splitting of uranium nuclei to disposal of nuclear waste.
24. **Hint—** Your answer must include: working of a solar device using reflectors/solar cell. Limitations: Available during day time/sunny

days. Requires huge installations and costly. To overcome limitation: Use of solar cell.

- 25. Hint—** Conventional: Fossil fuels, water, wind, Biomass etc.
Non Conventional: Nuclear, Solar, Energy from ocean, Geothermal etc. Explain the use of one of Non conventional source of energy.
- 26. Hint—** (i) Fossil fuels are depleting, Population is increasing, Quality of life is to be improved etc.
- (ii) Tidal/wave/OTEC
- 27. Hint—** Air pollution, Green house effect, Environment consequences: Acid rain, global warming etc. Steps: Use of smokeless appliances, Refined technology, Judicious use of energy etc.
- 28. Hint—** Sun is the ultimate source of energy. Justify by explaining the direct or indirect dependence of different sources of energy on Sun.
- 29. Hint—** Biomass: Plant and animal wastes. Give description of biogas plant with the help of a labelled diagram.



CHAPTER 15

ANSWERS

Multiple Choice Questions

1. (b) 2. (a) 3. (c) 4. (d)
5. (c) 6. (a) 7. (b) 8. (c)
9. (a) 10. (a) 11. (c) 12. (d)
13. (a) 14. (b) 15. (c) 16. (a)
17. (c) 18. (d) 19. (b) 20. (c)
21. (d)

Short Answer Questions

22. Wastes pollute our environment, air, soil and water, and cause harmful effects on all living organisms.
23. Phytoplanktons and aquatic plants → small aquatic animals (larvae, insects etc) → fish → bird
24. Cloth bags are
- (a) capable of carrying more things
 - (b) made of biodegradable material
 - (c) do not pollute our environment
 - (d) can be reused
25. Crop fields are man made and some biotic and abiotic components are manipulated by humans
26. Substances that are broken down into simpler substances by biological processes are said to be biodegradable. Examples, wood, paper.
Substances that cannot be broken down into simpler ones by biological processes are said to be non-biodegradable. Examples, plastic, DDT.
27. (a) Environment/biosphere
(b) Trophic level
(c) Abiotic factors
(d) Consumers/heterotrophs

28. Decomposers break down the dead and decaying organic matter and return the nutrients to the soil. Thus, they play a very important role in the nutrient re-cycling in the environment.
29. (b) Is not a matching pair
Both biotic and abiotic components of environment constitute an ecosystem
30. An aquarium is an artificial and incomplete ecosystem in contrast to a pond/lake which are natural, self-sustaining and complete ecosystems.

Long Answer Questions

31. The flow of energy generally is Sun → producer → herbivore → carnivore. Since the flow is progressively from one trophic level to another and does not revert back, it is said to be unidirectional. Further, the available energy decreases in the higher trophic levels making it impossible for energy to flow in the reverse direction.
32. Decomposers break down the complex organic substances of garbage, dead animals and plants into simpler inorganic substances that go into the soil and are used up again by the plants in the absence of decomposers recycling of material in the biosphere will not take place.
33. **Hints—** (i) Separation of biodegradable and non-biodegradable substances.
(ii) Gardening
(iii) Use of gunny bags/paper bags in place of polythene/plastic bags
(iv) Use of compost and vermicompost in place of fertilisers
(v) Harvesting rain water
- 34.

Food chain	Food Web
(a) Food chain is a series of organisms feeding on one another (b) Members of higher trophic level feed upon a single type of organism of the lower trophic level	(a) Food web consists of a number of interlinked food chains. (b) Members of higher trophic level can feed upon organisms of the lower trophic levels of other food chain.

35. Hints— (a) Kitchen wastes

- (b) Paper wastes like newspapers, bags, envelopes
- (c) Plastic bags
- (d) Vegetable/fruit peels/rind

Measures for disposal

- (a) Segregation of biodegradable and non-biodegradable wastes.
- (b) Safe disposal of plastic bags.
- (c) Vegetable/fruit peels can be placed near trees/plants, which on decomposition will enrich the soil with nutrients.
- (d) Give paper wastes for recycling.
- (e) Prepare a compost pit for kitchen wastes.

36. Hints— (a) Control air pollution

- (b) The effluent should be treated before discharge into surrounding environment.

37. The harmful by products are gases such as SO_2 and NO . They cause extensive air pollution and are responsible for acid rain.

38. Hints— (a) Excessive use of fertilisers changes the chemistry of soil and kills useful microbes.

- (b) Excessive use of non-biodegradable chemical pesticides leads to biological magnification.
- (c) Extensive cropping causes loss of soil fertility.
- (d) Excess use of ground water for agriculture lowers the water table.
- (e) Damage to natural ecosystem/habitat.



CHAPTER 16

ANSWERS

Multiple Choice Questions

- | | | | |
|---------|---------|---------|---------|
| 1. (c) | 2. (b) | 3. (b) | 4. (a) |
| 5. (b) | 6. (a) | 7. (d) | 8. (c) |
| 9. (a) | 10. (b) | 11. (d) | 12. (a) |
| 13. (b) | 14. (c) | 15. (c) | 16. (d) |
| 17. (c) | 18. (b) | 19. (a) | 20. (d) |
| 21. (c) | 22. (c) | 23. (d) | 24. (b) |

Short Answer Questions

25. Paper, rexin bag, blade, pen, plastic box, scale, eraser, compass and dividers (metallic), steel lunch box, steel spoon.

Paper, blade, plastic box, eraser, compass, steel lunch box and steel spoon can be recycled

26. **Hint—** (a) The ground water level increases due to recharging of wells.

(b) Ground water keeps the layers of soil above it moist and prevents loss of water by evaporation.

(c) The water can be stored during rainy season and can be used when required

27. Since people used excessive fertilisers in the fields, they were carried down to the lake during rains. As many fertilisers contain phosphates and nitrates, the water body became enriched with these chemicals. These chemicals promote excessive growth of aquatic plants and the surface of water was completely covered with plants. (eutrophication)

Depletion of light in the water body and insufficient availability of dissolved oxygen and nutrients resulted in the death of fish.

28. **Hint—**

(a) Put off the fans and lights when they are not required.

(b) Maximum use of solar radiation.

(c) Use of solar water heating system. during winters.

(d) Use of fluorescent tubes or CFL

29. Both the energy sources coal and petroleum take millions of years for their formation. As these resources are being utilised at a much faster rate than their formation, they will be exhausted in the near future, hence they need to be conserved.
30. **Hint—** (a) Reduce the consumption of petrol in the automobiles.
 (b) Use of CNG or clean fuel
 (c) Instead of burning litter prepare manure out of it.
 (d) Treatment of smoke to remove harmful gases before discharging into atmospheric
 (e) Plant more trees
31. (A) The water reservoir is a pond in Figure 16.1 (a) and underground water body in the Figure 16.1 (b).
 (B) Figure 16.1 (b) has more advantage than Figure 16.1 (a), because the advantages of water stored in the ground are many. For example
 (a) It does not evaporate
 (b) It spreads out to recharge wells.
 (c) Provides moisture for vegetation over a wide area.
 (d) It is protected from contamination by animal and human wastes.
 (e) It prevents breeding of insects.

Long Answer Questions

32. **Reduce** means to use a material/commodity in lesser quantity, e.g. electricity and water
- Recycle** means a material that is used once is collected and sent back to a manufacturer so that they can make some other useful material from it:
 e.g., plastic cups and buckets, glass tumbler, paper, metal objects
- Reuse** means using a thing over and over again instead of throwing it away. It does not involve the process of recycling either in small or large scale: e.g., used envelopes, plastic carry bags, bottles of jam.
33. **Hint—** (a) Unused water in the water bottle may be used for watering plant
 (b) Close all the taps before you go to sleep.
 (c) Avoid using a hose pipe for watering plants
 (d) Wash vehicles only when they are dirty
 (e) Use fan and light only when required
 (f) Use solar water heating devices
 (g) Use CFL in place of conventional bulbs/tubes

- 34. Hint—** The total amount of fresh water is more than enough to meet the needs of human beings. But due to its uneven distribution, wide seasonal as well as yearly fluctuation in rainfalls and wastage water shortage is a chronic problem in most parts of the world.
- 35. Hint—** Waste water can be used for
- (a) recharging the ground water
 - (b) can be used for irrigation
 - (c) treated municipal water can be used for washing cars, watering the gardens
 - (c) certain pollutants in sewage water can become fertiliser for various crops.
- 36. Hint—** Forests are renewable resources which provide
- (a) Habitat, food, protection to wild life.
 - (b) Help in balancing CO_2 and O_2 of atmosphere.
 - (c) Improves water holding capacity of soil.
 - (d) Regulates water cycle.
 - (e) For human being, they are the source for all essential commodities like, fuel wood, timber pulp and paper etc.
 - (f) It provides useful products like fruits, resins, gums, essential oils, bidi wrapper etc.
- 37. Hint—** The forest department developed a strategy in which the villagers were involved in the protection of the forest. In return for the labour, the villagers were paid and also had some benefit in harvesting operations. They were allowed to collect wood and fodder on payment of nominal fee. In this way, by the active and willing participation of the local people, the sal forests of Arabari were conserved.

